



**PM DIDOT**  
LE CARDAN FRANÇAIS

**Flexibles & composants  
hydrauliques**

# HISTORIQUE PM-DIDOT

Fondée en 1987 par Pierre-Louis MARIE, l'entreprise PM-DIDOT, basée à Villers-Bocage en Normandie, est spécialisée dans la fourniture de cardan agricole.

Depuis 1989, PM-DIDOT est associé avec un comptoir d'importation Hohing, situé à Hong-Kong, qui réalise un sourcing permanent visant à proposer les meilleurs produits en termes de rapport qualité / prix. Hohing, par une veille active, est également force de proposition pour l'importation de nouveaux produits manufacturés à la demande de notre clientèle.

Spécialiste reconnu et historique de la pièce de cardan agricole, PM-DIDOT connaît une nouvelle phase de développement en janvier 2017 avec sa reprise par Frédéric JOUINI.

Issu du monde de l'industrie automobile, Frédéric JOUINI, avec l'aide incontournable des 3 salariés historiques de la société et le soutien financier de la Région Normandie (350 000 euros d'aide), apporte de nombreux changements visant à un développement fort de l'entreprise :

- Une amélioration du process qualité, matérialisé par un résultat probant avec moins de 1% du chiffre d'affaire en coût qualité.
- Nouveau développement pour la gamme PM-DIDOT en 2018 et 2019 avec notamment des cardans pour les fortes puissances et une gamme complète de limiteurs à cames pour les herses rotatives.
- Le développement d'une nouvelle marque de roulements et de paliers propre à l'entreprise : AT CAMP, avec notamment la possibilité de disposer de ces produits sous blister et non plus seulement en vrac.

- PM-DIDOT devient en 2017 et 2018 distributeur officiel des marques Bondioli et Comer.
- Un travail auprès des constructeurs de machines agricoles français qui peuvent faire appel au bureau d'étude de l'entreprise pour la réalisation de pièces sur plan spécifiques à leur matériel. Ces mêmes constructeurs peuvent aussi avoir recourt à des cardans et des pièces de cardans PM-DIDOT en première monte.
- Le développement de marchés de niche. Pour exemple, PM DIDOT est désormais le leader français de la fourniture de pneumatiques pour sulky.



Les chantiers 2019 ont été nombreux et comptent notamment :

- Le lancement de la marque PM-DIDOT « Le Cardan Français »
- Un renforcement du sourcing en Asie avec Hohing pour travailler avec les meilleures usines
- Une mise en valeur du savoir-faire français par la réalisation de toutes les étapes de finalisation et de l'assemblage des produits en France
- Le développement du bureau d'étude pour proposer de nouveaux produits et de nouvelles gammes
- Une plateforme logistique à Villers-Bocage en Normandie, au bord de l'autoroute A84 permettant de gérer et d'expédier les produits commandés en temps record.
- La constitution d'un stock de produits important d'une valeur de plus d'1 millions d'euros permettant des livraisons sous 24 à 72h.

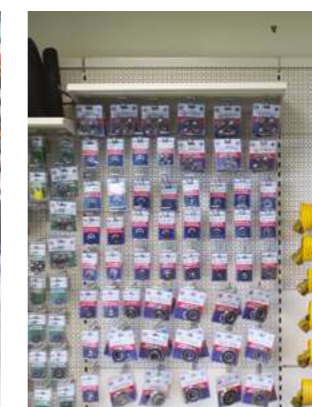

## PM-DIDOT AUJOURD'HUI

PM-DIDOT se caractérise aujourd'hui par sa volonté de proposer aux constructeurs de machines agricoles et aux enseignes fournissant les pièces détachées agricoles des gammes complètes de produits, réparties dans ces grandes familles :

- Transmission et pièces de transmissions agricoles
- Boîtiers renvoie d'angle et réducteurs agricoles
- Flexibles et raccords hydrauliques
- Croisillons de pont et 4x4
- Chaînes à rouleaux
- Roulements et paliers
- Pneumatiques et chambres à air de Fenaison
- Equin





## BESOINS DE PRODUITS HORS CATALOGUE ?

Contactez-nous au :

**02 31 25 40 07**  
**contact@pm-didot.fr**

### DES LIVRAISONS DANS TOUTE LA FRANCE

**DIRECTION :**  
02 31 25 40 07  
fjouini@pm-didot.fr

**COMPTABILITÉ**  
02 31 25 40 07  
ccabouret@pm-didot.fr

**SAV :**  
02 31 25 40 07  
cgasson@pm-didot.fr

**Commercial**  
02 31 25 40 07  
cgasson@pm-didot.fr



### Vous souhaitez accéder à nos tarifs ?

Rendez-vous sur notre site internet [www.pm-didot.fr](http://www.pm-didot.fr), puis cliquez sur le lien

ouverture d'un compte professionnel et remplissez le formulaire. À très vite.

# PM DIDOT

## RÉALISATION DE PIÈCES SUR-MESURE POUR VOS BESOINS

Développement en  
bureau d'études

Sourcing  
pour fabrication

Suivi  
qualité

Organisation  
logistique

**RENDEZ-VOUS SUR NOTRE SITE :**

**[www.pm-didot.fr](http://www.pm-didot.fr)**

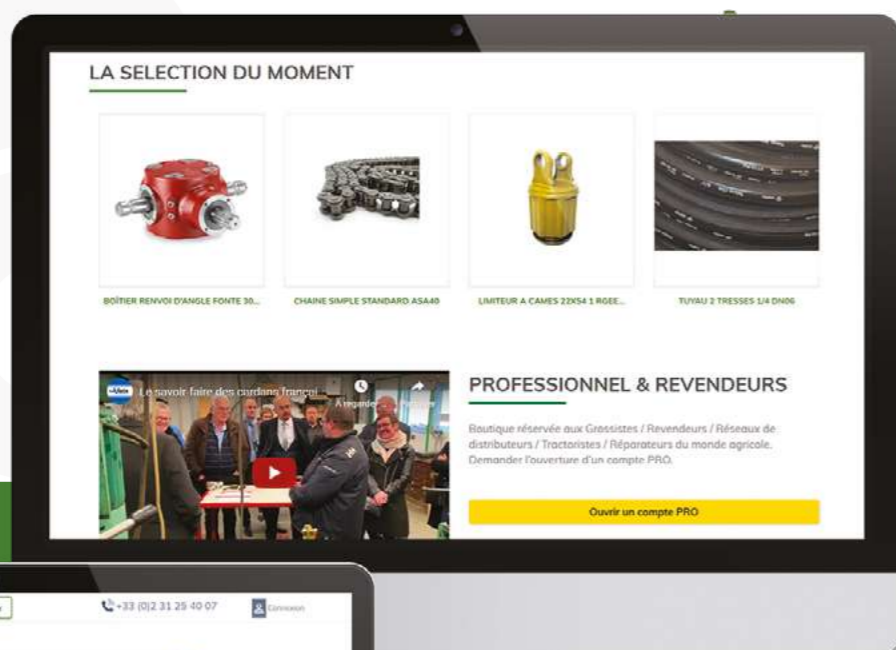

# UNE GAMME COMPLÈTE

de transmissions et pièces détachées :

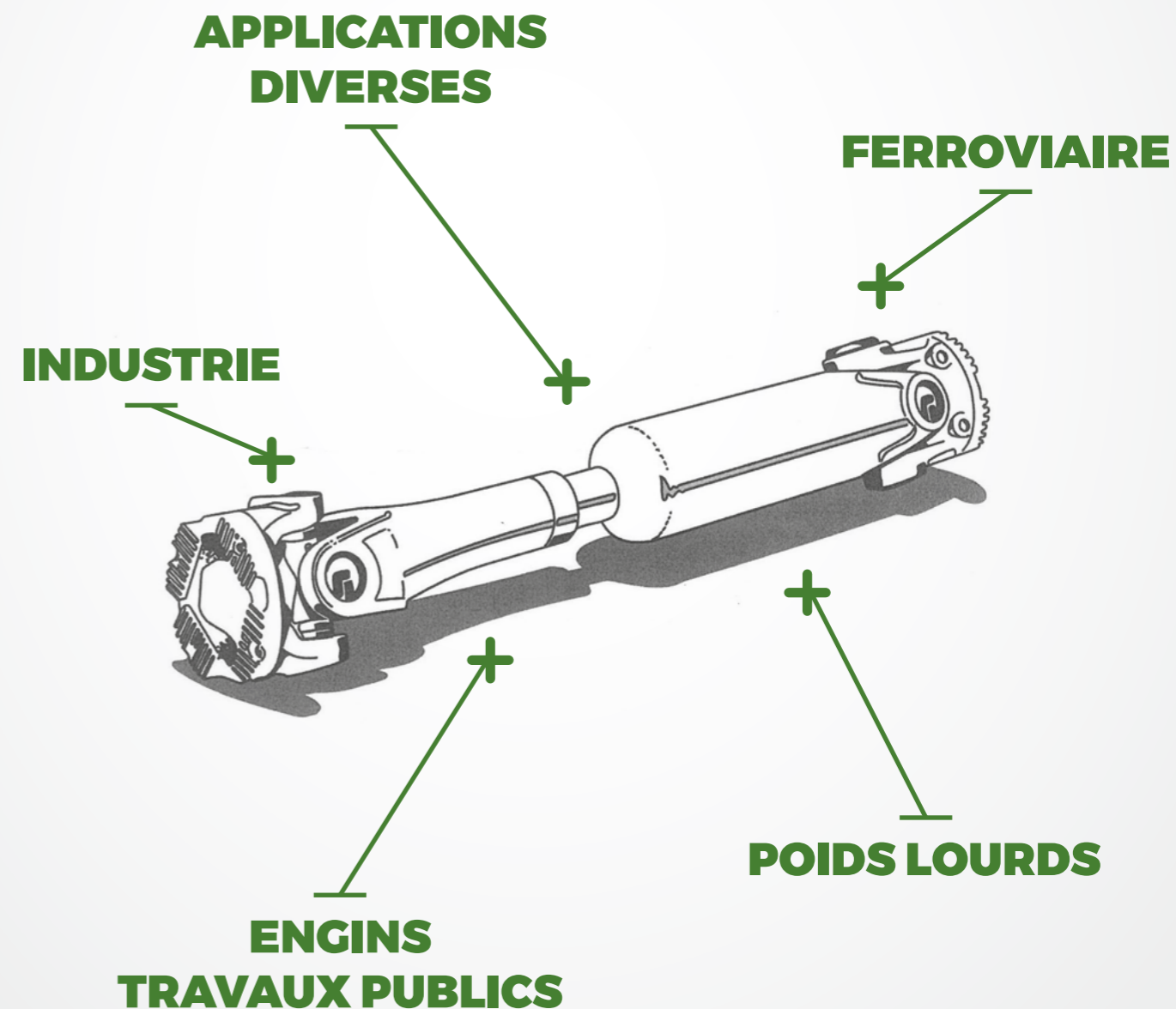

**CONTACTEZ NOUS POUR UN CARDAN SUR-MESURE**



# HYDRAULIQUE

Flexibles.....	p99
Protections.....	p100
Jupes.....	p101
Embouts.....	p102
BSP.....	p102
Din série L.....	p107
Din série S.....	p110
Gaz français.....	p113
JIC.....	p115
ORFS.....	p118
Double jonction.....	p120
Laveurs HP.....	p120
Valves agricoles.....	p120
Bagues & écrous.....	p121
Din L & S.....	p121
Gaz français.....	p122
Raccords union double & adaptateur....	p123
Din L et S.....	p123
Gaz français.....	p128
Coudes.....	p130
Din L & S.....	p130
Gaz français.....	p133
Té.....	p134
Din L & S.....	p134
Gaz français.....	p134
Coupleurs.....	p135
Valves & vannes.....	p137



## FLEXIBLES



### FLEXIBLE 2 TRESSSES ACIER PEAU MINCE EN 853 2 SN / SAE 100 R2 AT



DN	Tuyau	Code origine	Référence origine	Désignation
06	1/4	010140010	R2T1/4	TUYAU 2 TRESSSES 1/4 DN06
08	5/16	010141020	R2T5/16	TUYAU 2 TRESSSES 5/16 DN08
10	3/8	010142030	R2T3/8	TUYAU 2 TRESSSES 3/8 DN10
12	1/2	010143040	R2T1/2	TUYAU 2 TRESSSES 1/2 DN13
16	5/8	010144050	R2T5/8	TUYAU 2 TRESSSES 5/8 DN16
20	3/4	010145060	R2T3/4	TUYAU 2 TRESSSES 3/4 DN19
25	1	010146070	R2T1	TUYAU 2 TRESSSES 1 DN25
32	1 1/4	010147080	R2T1 1/4	TUYAU 2 TRESSSES 1 1/4 DN32
40	1 1/2	010148090	R2T1 1/2	TUYAU 2 TRESSSES 1 1/2 DN38
50	2	010149100	R2T2	TUYAU 2 TRESSSES 2 DN50

### FLEXIBLE 4 NAPPES ACIER 4 SP / EN 856 4 SP / SAE 100 R9R



DN	Tuyau	Code origine	Référence origine	Désignation
06	1/4	010 180 010	R9R1/4	TUYAU R9R 4SP 1/4 DN06
10	3/8	010 181 020	R9R3/8	TUYAU R9R 4SP 3/8 DN10
12	1/2	010 182 030	R9R1/2	TUYAU R9R 4SP 1/2 DN13
16	5/8	010 183 040	R9R5/8	TUYAU R9R 4SP 5/8 DN16
20	3/4	010 184 050	R9R3/4	TUYAU R9R 4SP 3/4 DN19
25	1	010 185 060	R9R1	TUYAU R9R 4SP 1 DN25
32	1 1/4	010 186 070	R9R1 1/4	TUYAU R9R 4SP 1 1/4 DN32
40	1 1/2	010 187 080	R9R1 1/2	TUYAU R9R 4SP 1 1/2 DN38
50	2	010 188 090	R9R2	TUYAU R9R 4SP 2 DN50

### FLEXIBLE 4 NAPPES ACIER 4SH / EN 856 4SH



DN	Tuyau	Code origine	Référence origine	Désignation
20	3/4	010 200 010	4SH3/4	TUYAU 4SH 3/4 DN19
25	1	010 210 020	4SH1	TUYAU 4SH 1 DN25
32	1 1/4	010 220 030	4SH1 1/4	TUYAU 4SH 1 1/4 DN32
40	1 1/2	010 230 040	4SH1 1/2	TUYAU 4SH 1 1/2 DN38
50	2	010 240 050	4SH2	TUYAU 4SH 2 DN50

### FLEXIBLE COMPACT 2 TRESSSES ACIER LAVAGE BLEU / IEC-60335-2



DN	Tuyau	Code origine	Référence origine	Désignation
06	1/4	010 330 010	2SC 1/4 B-LAV	LAVAGE BLEU 2 TRESSSES 1/4 DN06
08	5/16	010 331 020	2SC 5/16 B-LAV	LAVAGE BLEU 2 TRESSSES 5/16 DN08
10	3/8	010 332 030	2SC 3/8 B-LAV	LAVAGE BLEU 2 TRESSSES 3/8 DN10
12	1/2	010 333 040	2SC 1/2 B-LAV	LAVAGE BLEU 2 TRESSSES 1/2 DN13



# PROTECTIONS



Une demande spécifique ?  
contactez-nous



[www.pm-didot.fr](http://www.pm-didot.fr)

## RESSORT DE PROTECTION SPIRALE



Code origine	Référence origine	Désignation
120 010 010	RPS10X13	RESSORT PROTECTION TUYAU 10X13
120 010 020	RPS13X16	RESSORT PROTECTION TUYAU 13X16
120 010 030	RPS16X20	RESSORT PROTECTION TUYAU 16X20
120 010 040	RPS20X25	RESSORT PROTECTION TUYAU 20X25
120 010 050	RPS27X32	RESSORT PROTECTION TUYAU 27X32
120 010 060	RPS35X40	RESSORT PROTECTION TUYAU 35X40
120 010 070	RPS44X50	RESSORT PROTECTION TUYAU 44X50
120 010 080	RPS55X63	RESSORT PROTECTION TUYAU 55X63
120 010 090	RPS65X75	RESSORT PROTECTION TUYAU 65X75
120 010 100	RPS80X90	RESSORT PROTECTION TUYAU 80X90
120 010 110	RPS100X110	RESSORT PROTECTION TUYAU 100X110

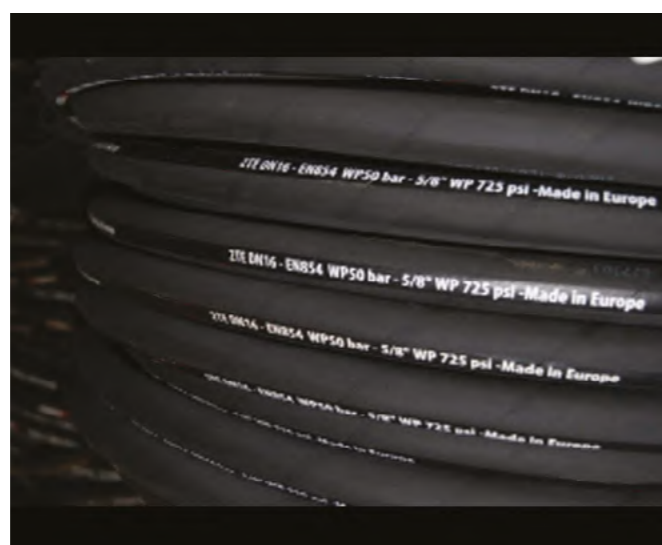

# JUPES



## JUPE A SERTIR SANS DENUDAGE

Juqe RIT-RT-2SC - Ferrule RIT-R2T-2SC

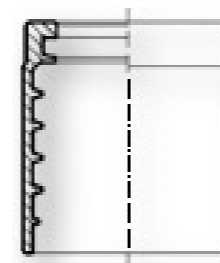

DN	Tuyau	Filetage	Code origine	Référence origine
5	3/16		020 120 100	JST104
5	3/16		020 120 101	JST204
6	1/4		020 120 102	JST206
8	5/16		020 120 103	JST208
10	3/8		020 120 104	JST210
12	1/2		020 120 105	JST213
16	5/8		020 120 106	JST216
20	3/4		020 120 107	JST219
25	1		020 120 108	JST225
32	1 1/4		020 120 109	JST232
40	1 1/2		020 120 110	JST238
50	2		020 120 111	JST250
65	2 1/2		020 120 112	JST265
73	3		020 120 113	JST275

## JUPE A SERTIR 4SP

Juqe R9R-4SP - Ferrule R9R-4SP

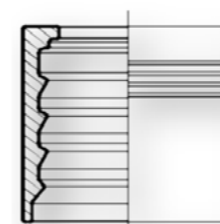

DN	Tuyau	Filetage	Code origine	Référence origine
6	1/4		020 160 102	JSR906
10	3/8		020 160 104	JSR910
12	1/2		020 160 105	JSR913
16	5/8		020 160 106	JSR916
20	3/4		020 160 107	JSR919
25	1		020 160 108	JSR925
32	1 1/4		020 160 109	JSR932
40	1 1/2		020 160 110	JSR938
50	2		020 160 111	JSR950



# EMBOUTS / SÉRIE BSP



## EMBOUT MALE CONE 60° BSPP

BSP Mâle parallèle 60° Cone seat

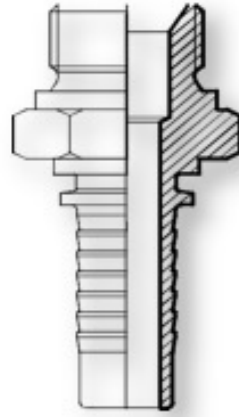

DN	Tuyau	Filetage	Code origine	Référence origine
5	3/16	1/8 GAZ	040 100 100	ES04MBSP1/8
5	3/16	1/4 GAZ	040 100 110	ES04MBSP1/4
6	1/4	1/8 GAZ	040 100 120	ES06MBSP1/8
6	1/4	1/4 GAZ	040 100 130	ES06MBSP1/4
6	1/4	3/8 GAZ	040 100 140	ES06MBSP3/8
6	1/4	1/2 GAZ	040 100 150	ES06MBSP1/2
8	5/16	1/4 GAZ	040 100 160	ES08MBSP1/4
8	5/16	3/8 GAZ	040 100 170	ES08MBSP3/8
8	5/16	1/2 GAZ	040 100 180	ES08MBSP1/2
10	3/8	1/4 GAZ	040 100 190	ES10MBSP1/4
10	3/8	3/8 GAZ	040 100 200	ES10MBSP3/8
10	3/8	1/2 GAZ	040 100 210	ES10MBSP1/2
12	1/2	3/8 GAZ	040 100 220	ES13MBSP3/8
12	1/2	1/2 GAZ	040 100 230	ES13MBSP1/2
12	1/2	5/8 GAZ	040 100 240	ES13MBSP5/8
12	1/2	3/4 GAZ	040 100 250	ES13MBSP3/4
16	5/8	1/2 GAZ	040 100 260	ES16MBSP1/2
16	5/8	5/8 GAZ	040 100 270	ES16MBSP5/8
16	5/8	3/4 GAZ	040 100 280	ES16MBSP3/4
20	3/4	1/2 GAZ	040 100 290	ES19MBSP1/2
20	3/4	5/8 GAZ	040 100 300	ES19MBSP5/8
20	3/4	3/4 GAZ	040 100 310	ES19MBSP3/4
20	3/4	1 GAZ	040 100 320	ES19MBSP1
25	1	3/4 GAZ	040 100 330	ES25MBSP3/4
25	1	1 GAZ	040 100 340	ES25MBSP1
25	1	1 1/4 GAZ	040 100 350	ES25MBSP1 1/4
32	1 1/4	1 1/4 GAZ	040 100 360	ES32MBSP1 1/4
32	1 1/4	1 1/2 GAZ	040 100 370	ES32MBSP1 1/2
40	1 1/2	1 1/2 GAZ	040 100 380	ES38MBSP1 1/2
40	1 1/2	2 GAZ	040 100 390	ES38MBSP2
50	2	2 GAZ	040 100 400	ES50MBSP2
63	2 1/2	2 1/2 GAZ	040 100 410	ES63MBSP2 1/2
73	3	3 GAZ	040 100 420	ES73MBSP3



Une demande spécifique ?  
contactez-nous



[www.pm-didot.fr](http://www.pm-didot.fr)

## EMBOUT FEMELLE DROIT BSPP / CONE 60°

BSP Straight female 60° Cone

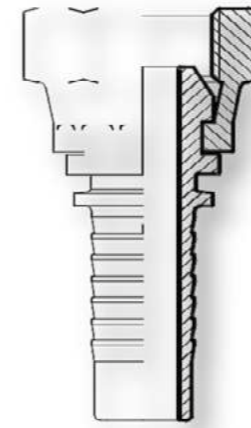

DN	Tuyau	Filetage	Code origine	Référence origine
5	3/16	1/8 GAZ	040 140 100	ES04FBSP1/8
5	3/16	1/4 GAZ	040 140 110	ES04FBSP1/4
6	1/4	1/8 GAZ	040 140 120	ES06FBSP1/8
6	1/4	1/4 GAZ	040 140 130	ES06FBSP1/4
6	1/4	3/8 GAZ	040 140 140	ES06FBSP3/8
6	1/4	1/2 GAZ	040 140 150	ES06FBSP1/2
8	5/16	1/4 GAZ	040 140 160	ES08FBSP1/4
8	5/16	3/8 GAZ	040 140 170	ES08FBSP3/8
8	5/16	1/2 GAZ	040 140 180	ES08FBSP1/2
10	3/8	1/4 GAZ	040 140 190	ES10FBSP1/4
10	3/8	3/8 GAZ	040 140 200	ES10FBSP3/8
10	3/8	1/2 GAZ	040 140 210	ES10FBSP1/2
12	1/2	3/8 GAZ	040 140 220	ES13FBSP3/8
12	1/2	1/2 GAZ	040 140 230	ES13FBSP1/2
12	1/2	5/8 GAZ	040 140 240	ES13FBSP5/8
12	1/2	3/4 GAZ	040 140 250	ES13FBSP3/4
16	5/8	1/2 GAZ	040 140 260	ES16FBSP1/2
16	5/8	5/8 GAZ	040 140 270	ES16FBSP5/8
16	5/8	3/4 GAZ	040 140 280	ES16FBSP3/4
20	3/4	1/2 GAZ	040 140 290	ES19FBSP1/2
20	3/4	5/8 GAZ	040 140 300	ES19FBSP5/8
20	3/4	3/4 GAZ	040 140 310	ES19FBSP3/4
20	3/4	1 GAZ	040 140 320	ES19FBSP1
25	1	3/4 GAZ	040 140 330	ES25FBSP3/4
25	1	1 GAZ	040 140 340	ES25FBSP1
25	1	1 1/4 GAZ	040 140 350	ES25FBSP1 1/4
32	1 1/4	1 1/4 GAZ	040 140 360	ES32FBSP1 1/4
32	1 1/4	1 1/2 GAZ	040 140 370	ES32FBSP1 1/2
40	1 1/2	1 1/2 GAZ	040 140 380	ES38FBSP1 1/2
40	1 1/2	2 GAZ	040 140 390	ES38FBSP2
50	2	2 GAZ	040 140 400	ES50FBSP2
		2 1/2 GAZ	040 140 410	ES63FBSP2 1/2
		3 GAZ	040 140 420	ES73FBSP3

## EMBOUT FEMELLE BSPP COUDE 90° / CONE 60°

90° BSP Straight female swept elbow 60° cone

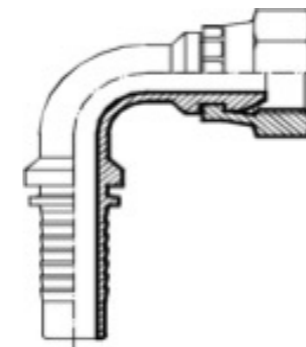

DN	Tuyau	Filetage	Code origine	Référence origine
5	3/16	1/8 GAZ	040 160 100	ES04FBSP1/8-90
5	3/16	1/4 GAZ	040 160 110	ES04FBSP1/4-90
6	1/4	1/8 GAZ	040 160 120	ES06FBSP1/8-90
6	1/4	1/4 GAZ	040 160 130	ES06FBSP1/4-90
6	1/4	3/8 GAZ	040 160 140	ES06FBSP3/8-90
6	1/4	1/2 GAZ	040 160 150	ES06FBSP1/2-90
8	5/16	1/4 GAZ	040 160 160	ES08FBSP1/4-90
8	5/16	3/8 GAZ	040 160 170	ES08FBSP3/8-90
8	5/16	1/2 GAZ	040 160 180	ES08FBSP1/2-90
10	3/8	1/4 GAZ	040 160 190	ES10FBSP1/4-90



### EMBOU FEMELLE BSPP COUDE 90° / CONE 60° (SUITE)

90° BSP Straight female swept elbow 60° cone

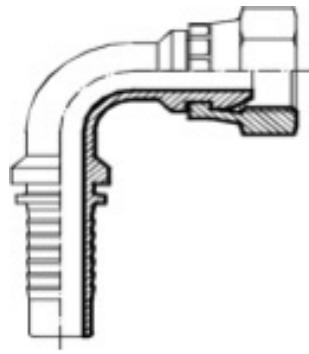

DN	Tuyau	Filetage	Code origine	Référence origine
10	3/8	3/8 GAZ	040 160 200	ES10FBSP3/8-90
10	3/8	1/2 GAZ	040 160 210	ES10FBSP1/2-90
12	1/2	3/8 GAZ	040 160 220	ES13FBSP3/8-90
12	1/2	1/2 GAZ	040 160 230	ES13FBSP1/2-90
12	1/2	5/8 GAZ	040 160 240	ES13FBSP5/8-90
12	1/2	3/4 GAZ	040 160 250	ES13FBSP3/4-90
16	5/8	1/2 GAZ	040 160 260	ES16FBSP1/2-90
16	5/8	5/8 GAZ	040 160 270	ES16FBSP5/8-90
16	5/8	3/4 GAZ	040 160 280	ES16FBSP3/4-90
20	3/4	1/2 GAZ	040 160 290	ES19FBSP1/2-90
20	3/4	5/8 GAZ	040 160 300	ES19FBSP5/8-90
20	3/4	3/4 GAZ	040 160 310	ES19FBSP3/4-90
20	3/4	1 GAZ	040 160 320	ES19FBSP1-90
25	1	3/4 GAZ	040 160 330	ES25FBSP3/4-90
25	1	1 GAZ	040 160 340	ES25FBSP1-90
25	1	1 1/4 GAZ	040 160 350	ES25FBSP1 1/4-90
32	1 1/4	1 1/4 GAZ	040 160 360	ES32FBSP1 1/4-90
32	1 1/4	1 1/2 GAZ	040 160 370	ES32FBSP1 1/2-90
40	1 1/2	1 1/2 GAZ	040 160 380	ES38FBSP1 1/2-90
40	1 1/2	2 GAZ	040 160 390	ES38FBSP2-90
50	2	2 GAZ	040 160 400	ES50FBSP2-90
		2 1/2 GAZ	040 160 410	ES63FBSP2 1/2-90
		3 GAZ	040 160 420	ES73FBSP3-90

### EMBOU FEMELLE BSPP COUDE 45° / CONE 60°

45° BSP Female swept elbow 60° cone

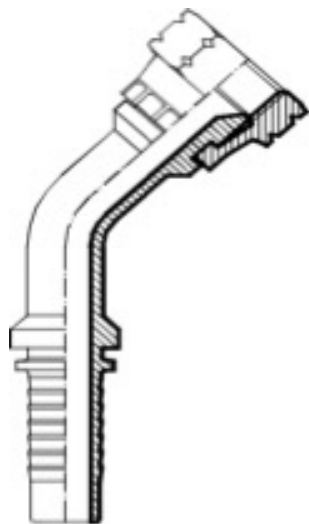

DN	Tuyau	Filetage	Code origine	Référence origine
5	3/16	1/8 GAZ	040 180 100	ES04FBSP1/8-45
5	3/16	1/4 GAZ	040 180 110	ES04FBSP1/4-45
6	1/4	1/8 GAZ	040 180 120	ES06FBSP1/8-45
6	1/4	1/4 GAZ	040 180 130	ES06FBSP1/4-45
6	1/4	3/8 GAZ	040 180 140	ES06FBSP3/8-45
6	1/4	1/2 GAZ	040 180 150	ES06FBSP1/2-45
8	5/16	1/4 GAZ	040 180 160	ES08FBSP1/4-45
8	5/16	3/8 GAZ	040 180 170	ES08FBSP3/8-45
8	5/16	1/2 GAZ	040 180 180	ES08FBSP1/2-45
10	3/8	1/4 GAZ	040 180 190	ES10FBSP1/4-45
10	3/8	3/8 GAZ	040 180 200	ES10FBSP3/8-45
10	3/8	1/2 GAZ	040 180 210	ES10FBSP1/2-45
12	1/2	3/8 GAZ	040 180 220	ES13FBSP3/8-45
12	1/2	1/2 GAZ	040 180 230	ES13FBSP1/2-45
12	1/2	5/8 GAZ	040 180 240	ES13FBSP5/8-45
12	1/2	3/4 GAZ	040 180 250	ES13FBSP3/4-45
16	5/8	1/2 GAZ	040 180 260	ES16FBSP1/2-45
16	5/8	5/8 GAZ	040 180 270	ES16FBSP5/8-45
16	5/8	3/4 GAZ	040 180 280	ES16FBSP3/4-45

### EMBOU FEMELLE BSPP COUDE 45° / CONE 60° (SUITE)

45° BSP Female swept elbow 60° cone

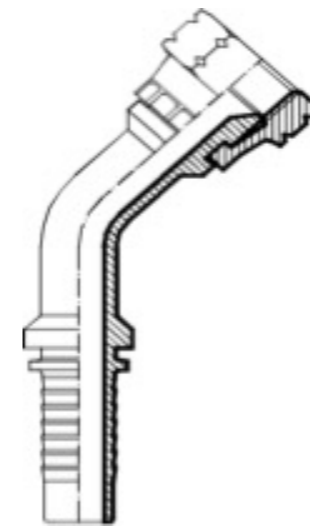

DN	Tuyau	Filetage	Code origine	Référence origine
20	3/4	1/2 GAZ	040 180 290	ES19FBSP1/2-45
20	3/4	5/8 GAZ	040 180 300	ES19FBSP5/8-45
20	3/4	3/4 GAZ	040 180 310	ES19FBSP3/4-45
20	3/4	1 GAZ	040 180 320	ES19FBSP1-45
25	1	3/4 GAZ	040 180 330	ES25FBSP3/4-45
25	1	1 GAZ	040 180 340	ES25FBSP1-45
25	1	1 1/4 GAZ	040 180 350	ES25FBSP1 1/4-45
32	1 1/4	1 1/4 GAZ	040 180 360	ES32FBSP1 1/4-45
32	1 1/4	1 1/2 GAZ	040 180 370	ES32FBSP1 1/2-45
40	1 1/2	1 1/2 GAZ	040 180 380	ES38FBSP1 1/2-45
40	1 1/2	2 GAZ	040 180 390	ES38FBSP2-45
50	2	2 GAZ	040 180 400	ES50FBSP2-45

### EMBOU FEMELLE DROIT GAZ FACE PLATE

BSP Straight female flat seat

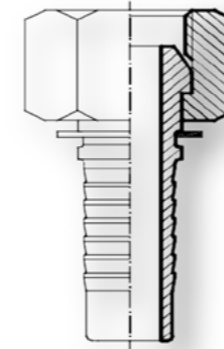

DN	Tuyau	Filetage	Code origine	Référence origine
6	1/4	1/4 GAZ	040 150 100	ES06TG1/4
6	1/4	3/8 GAZ	040 150 110	ES06TG3/8
8	5/16	3/8 GAZ	040 150 120	ES08TG3/8
10	3/8	3/8 GAZ	040 150 130	ES10TG3/8
10	3/8	1/2 GAZ	040 150 140	ES10TG1/2
12	1/2	1/2 GAZ	040 150 150	ES13TG1/2
12	1/2	5/8 GAZ	040 150 160	ES13TG5/8
12	1/2	3/4 GAZ	040 150 170	ES13TG3/4
16	5/8	5/8 GAZ	040 150 180	ES16TG5/8
16	5/8	3/4 GAZ	040 150 190	ES16TG3/4
20	3/4	3/4 GAZ	040 150 200	ES19TG3/4
20	3/4	1 GAZ	040 150 210	ES19TG1
25	1	1 GAZ	040 150 220	ES25TG1
32	1 1/4	1 1/4 GAZ	040 150 230	ES32TG1 1/4

### EMBOU MALE CONIQUE BSPT / CONE 60°

BSP mâle 60° cone

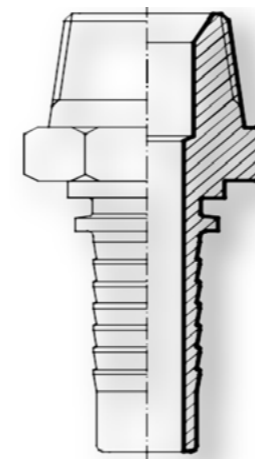

DN	Tuyau	Filetage	Code origine	Référence origine
5	3/16	1/8 GAZ	040 120 100	ES04MC1/8
5	3/16	1/4 GAZ	040 120 110	ES04MC1/4
6	1/4	1/8 GAZ	040 120 120	ES06MC1/8
6	1/4	1/4 GAZ	040 120 130	ES06MC1/4
6	1/4	3/8 GAZ	040 120 140	ES06MC3/8
6	1/4	1/2 GAZ	040 120 141	ES06MC1/2
8	5/16	1/4 GAZ	040 120 150	ES08MC1/4
8	5/16	3/8 GAZ	040 120 160	ES08MC3/8
10	3/8	1/4 GAZ	040 120 170	ES10MC1/4
10	3/8	3/8 GAZ	040 120 180	ES10MC3/8
10	3/8	1/2 GAZ	040 120 190	ES10MC1/2





## EMBOUT MALE CONIQUE BSPT / CONE 60° (SUITE)

BSP mâle 60° cone

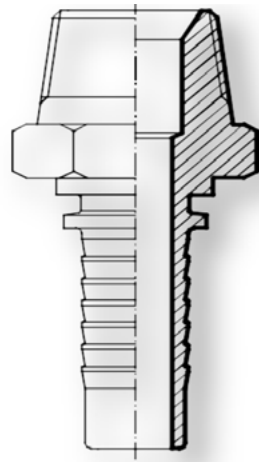

DN	Tuyau	Filetage	Code origine	Référence origine
12	1/2	3/8 GAZ	040 120 200	ES13MC3/8
12	1/2	1/2 GAZ	040 120 210	ES13MC1/2
16	5/8	1/2 GAZ	040 120 220	ES16MC1/2
16	5/8	3/4 GAZ	040 120 230	ES16MC3/4
20	3/4	3/4 GAZ	040 120 240	ES19MC3/4
20	3/4	1 GAZ	040 120 250	ES19MC1
25	1	1 GAZ	040 120 260	ES25MC1
25	1	1 1/4 GAZ	040 120 270	ES25MC1 1/4
32	1 1/4	1 1/4 GAZ	040 120 280	ES32MC1 1/4
32	1 1/4	1 1/2 GAZ	040 120 290	ES32MC1 1/2
40	1 1/2	1 1/2 GAZ	040 120 300	ES38MC1 1/2
50	2	2 GAZ	040 120 310	ES50MC2

## EMBOUT BANJO BSPP

BSP Banjo

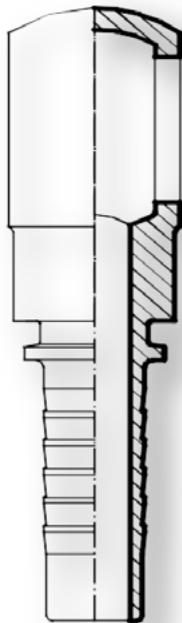

DN	Tuyau	Filetage	Code origine	Référence origine
5	3/16	1/8 GAZ	040 230 100	ES04BO1/8
5	3/16	1/4 GAZ	040 230 110	ES04BO1/4
6	1/4	1/8 GAZ	040 230 120	ES06BO1/8
6	1/4	1/4 GAZ	040 230 130	ES06BO1/4
6	1/4	3/8 GAZ	040 230 140	ES06BO3/8
6	1/4	1/2 GAZ	040 230 150	ES06BO1/2
8	5/16	1/4 GAZ	040 230 160	ES08BO1/4
8	5/16	3/8 GAZ	040 230 170	ES08BO3/8
8	5/16	1/2 GAZ	040 230 180	ES08BO1/2
10	3/8	1/4 GAZ	040 230 190	ES10BO1/4
10	3/8	3/8 GAZ	040 230 200	ES10BO3/8
10	3/8	1/2 GAZ	040 230 210	ES10BO1/2
12	1/2	3/8 GAZ	040 230 220	ES13BO3/8
12	1/2	1/2 GAZ	040 230 230	ES13BO1/2
12	1/2	5/8 GAZ	040 230 240	ES13BO5/8
12	1/2	3/4 GAZ	040 230 250	ES13BO3/4
16	5/8	5/8 GAZ	040 230 260	ES16BO5/8
16	5/8	3/4 GAZ	040 230 270	ES16BO3/4
20	3/4	3/4 GAZ	040 230 280	ES19BO3/4
20	3/4	1 GAZ	040 230 290	ES19BO1
20	3/4	3/4 GAZ	040 230 300	ES19BO3/4
25	1	1 GAZ	040 230 310	ES25BO1
32	1 1/4	1 1/4 GAZ	040 230 320	ES32BO1 1/4

Une demande spécifique ?  
contactez-nous



[www.pm-didot.fr](http://www.pm-didot.fr)

## EMBOUTS / DIN SÉRIE L



### EMBOUT MALE SERIE DIN L / CONE 24°

Metric mâle 24° cone L type

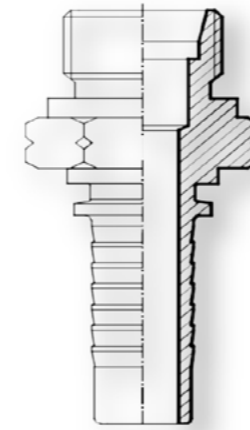

DN	Tuyau	Filetage	Code origine	Référence origine
5	3/16	12X150	040 290 100	ES04EM06L
5	3/16	14X150	040 290 110	ES04EM08L
6	1/4	12X150	040 290 120	ES06EM06L
6	1/4	14X150	040 290 130	ES06EM08L
6	1/4	16X150	040 290 140	ES06EM10L
6	1/4	18X150	040 290 150	ES06EM12L
8	5/16	14X150	040 290 160	ES08EM08L
8	5/16	16X150	040 290 170	ES08EM10L
8	5/16	18X150	040 290 180	ES08EM12L
10	3/8	16X150	040 290 190	ES10EM10L
10	3/8	18X150	040 290 200	ES10EM12L
10	3/8	22X150	040 290 210	ES10EM15L
12	1/2	18X150	040 290 220	ES13EM12L
12	1/2	22X150	040 290 230	ES13EM15L
12	1/2	26X150	040 290 240	ES13EM18L
16	5/8	26X150	040 290 250	ES16EM18L
16	5/8	30X200	040 290 260	ES16EM22L
20	3/4	26X150	040 290 270	ES19EM18L
20	3/4	30X200	040 290 280	ES19EM22L
25	1	36X200	040 290 290	ES25EM28L
32	1 1/4	45X200	040 290 300	ES32EM35L
40	1 1/2	52X200	040 290 310	ES38EM42L

### EMBOUT FEMELLE DROIT SERIE DIN L AVEC JOINT / CONE 24°

O Ring straight metric female 24° Cone L type

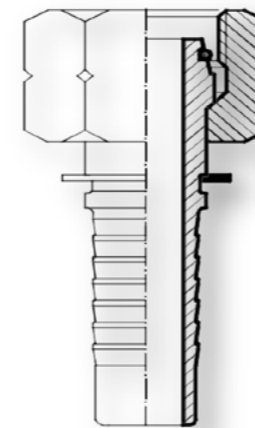

DN	Tuyau	Filetage	Code origine	Référence origine
5	3/16	12X150	040 300 100	ES04ETCO06L
5	3/16	14X150	040 300 110	ES04ETCO08L
5	3/16	16X150	040 300 120	ES04ETCO10L
6	1/4	12X150	040 300 130	ES06ETCO06L
6	1/4	14X150	040 300 140	ES06ETCO08L
6	1/4	16X150	040 300 150	ES06ETCO10L
6	1/4	18X150	040 300 160	ES06ETCO12L
8	5/16	14X150	040 300 170	ES08ETCO08L
8	5/16	16X150	040 300 180	ES08ETCO10L
8	5/16	18X150	040 300 190	ES08ETCO12L
10	3/8	16X150	040 300 200	ES10ETCO10L
10	3/8	18X150	040 300 210	ES10ETCO12L
10	3/8	22X150	040 300 220	ES10ETCO15L



### EMBOU FEMELLE DROIT SERIE DIN L AVEC JOINT / CONE 24° (SUITE)

O Ring straight metric female 24° Cone L type

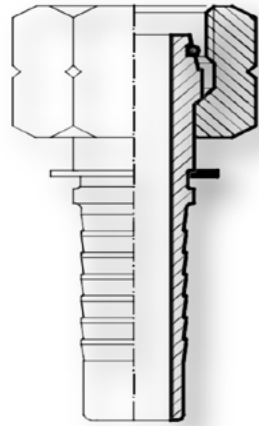

DN	Tuyau	Filetage	Code origine	Référence origine
12	1/2	18X150	040 300 230	ES13ETCO12L
12	1/2	22X150	040 300 240	ES13ETCO15L
12	1/2	26X150	040 300 250	ES13ETCO18L
16	5/8	26X150	040 300 260	ES16ETCO18L
16	5/8	30X200	040 300 270	ES16ETCO22L
20	3/4	26X150	040 300 280	ES19ETCO18L
20	3/4	30X200	040 300 290	ES19ETCO22L
25	1	36X200	040 300 300	ES25ETCO28L
32	1 1/4	45X200	040 300 310	ES32ETCO35L
40	1 1/2	52X200	040 300 320	ES38ETCO42L

### EMBOU FEMELLE SERIE DIN L AVEC JOINT COUDE 90° / CONE 24

90° O ring metric female swept elbow 24° Cone L Type

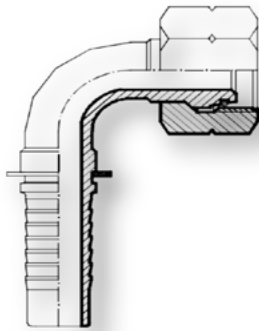

DN	Tuyau	Filetage	Code origine	Référence origine
5	3/16	12X150	040 310 100	ES04ETCO06L90
5	3/16	14X150	040 310 110	ES04ETCO08L90
5	3/16	16X150	040 310 120	ES04ETCO10L90
5	3/16	18X150	040 310 130	ES04ETCO12L90
6	1/4	12X150	040 310 140	ES06ETCO06L90
6	1/4	14X150	040 310 150	ES06ETCO08L90
6	1/4	16X150	040 310 160	ES06ETCO10L90
6	1/4	18X150	040 310 170	ES06ETCO12L90
8	5/16	14X150	040 310 180	ES08ETCO08L90
8	5/16	16X150	040 310 190	ES08ETCO10L90
8	5/16	18X150	040 310 200	ES08ETCO12L90
10	3/8	16X150	040 310 210	ES10ETCO10L90
10	3/8	18X150	040 310 220	ES10ETCO12L90
10	3/8	22X150	040 310 230	ES10ETCO15L90
12	1/2	18X150	040 310 240	ES13ETCO12L90
12	1/2	22X150	040 310 250	ES13ETCO15L90
12	1/2	26X150	040 310 260	ES13ETCO18L90
16	5/8	26X150	040 310 270	ES16ETCO18L90
16	5/8	30X200	040 310 280	ES16ETCO22L90
20	3/4	26X150	040 310 290	ES19ETCO18L90
20	3/4	30X200	040 310 300	ES19ETCO22L90
20	3/4	36X200	040 310 310	ES19ETCO28L90
25	1	36X200	040 310 320	ES25ETCO28L90
32	1 1/4	45X200	040 310 330	ES32ETCO35L90
40	1 1/2	52X200	040 310 340	ES38ETCO42L90



### EMBOU FEMELLE SERIE DIN L AVEC JOINT COUDE 45° / CONE 24

45° O ring metric female swept elbow 24° Cone L type

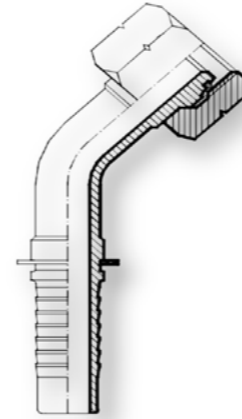

DN	Tuyau	Filetage	Code origine	Référence origine
5	3/16	12X150	040 320 100	ES04ETCO06L45
5	3/16	14X150	040 320 110	ES04ETCO08L45
5	3/16	16X150	040 320 120	ES04ETCO10L45
6	1/4	12X150	040 320 130	ES06ETCO06L45
6	1/4	14X150	040 320 140	ES06ETCO08L45
6	1/4	16X150	040 320 150	ES06ETCO10L45
6	1/4	18X150	040 320 160	ES06ETCO12L45
8	5/16	14X150	040 320 170	ES08ETCO08L45
8	5/16	16X150	040 320 180	ES08ETCO10L45
8	5/16	18X150	040 320 190	ES08ETCO12L45
10	3/8	16X150	040 320 200	ES10ETCO10L45
10	3/8	18X150	040 320 210	ES10ETCO12L45
10	3/8	22X150	040 320 220	ES10ETCO15L45
10	3/8	26X150	040 320 230	ES10ETCO18L45
12	1/2	22X150	040 320 240	ES13ETCO15L45
12	1/2	26X150	040 320 250	ES13ETCO18L45
16	5/8	26X150	040 320 260	ES16ETCO18L45
16	5/8	30X200	040 320 270	ES16ETCO22L45
20	3/4	26X150	040 320 280	ES19ETCO18L45
20	3/4	30X200	040 320 290	ES19ETCO22L45
25	1	36X200	040 320 300	ES25ETCO28L45
32	1 1/4	45X200	040 320 310	ES32ETCO35L45
40	1 1/2	45X200	040 320 320	ES38ETCO42L45



# EMBOUTS / DIN SÉRIE S



## EMBOUT MALE SERIE DIN S / CONE 24°

Metric male 24° cone S type

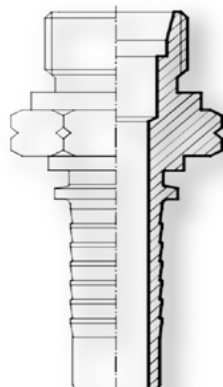

DN	Tuyau	Filetage	Code origine	Référence origine
5	3/16	14X150	040 330 100	ES04EM06S
5	3/16	16X150	040 330 110	ES04EM08S
6	1/4	14X150	040 330 120	ES06EM06S
6	1/4	16X150	040 330 130	ES06EM08S
6	1/4	18X150	040 330 140	ES06EM10S
6	1/4	20X150	040 330 150	ES06EM12S
8	5/16	18X150	040 330 160	ES08EM10S
8	5/16	20X150	040 330 170	ES08EM12S
10	3/8	18X150	040 330 180	ES10EM10S
10	3/8	20X150	040 330 190	ES10EM12S
10	3/8	22X150	040 330 200	ES10EM14S
12	1/2	22X150	040 330 210	ES13EM14S
12	1/2	24X150	040 330 220	ES13EM16S
16	5/8	30X200	040 330 230	ES16EM20S
20	3/4	30X200	040 330 240	ES19EM20S
20	3/4	36X200	040 330 250	ES19EM25S
25	1	36X200	040 330 260	ES25EM25S
25	1	42X200	040 330 270	ES25EM30S
32	1 1/4	42X200	040 330 280	ES32EM30S
32	1 1/4	52X200	040 330 290	ES32EM38S
40	1 1/2	52X200	040 330 300	ES38EM38S

## EMBOUT FEMELLE DROIT SERIE DIN S AVEC JOINT / CONE 24°

O ring straight metric female 24° cone type

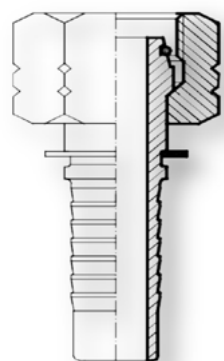

DN	Tuyau	Filetage	Code origine	Référence origine
5	3/16	14X150	040 340 100	ES04ETCO06S
5	3/16	16X150	040 340 110	ES04ETCO08S
6	1/4	14X150	040 340 120	ES06ETCO06S
6	1/4	16X150	040 340 130	ES06ETCO08S
6	1/4	18X150	040 340 140	ES06ETCO10S
6	1/4	20X150	040 340 150	ES06ETCO12S
8	5/16	18X150	040 340 160	ES08ETCO10S
8	5/16	20X150	040 340 170	ES08ETCO12S
10	3/8	18X150	040 340 180	ES10ETCO10S
10	3/8	20X150	040 340 190	ES10ETCO12S
10	3/8	22X150	040 340 200	ES10ETCO14S
10	3/8	24X150	040 340 210	ES10ETCO16S

## EMBOUT FEMELLE DROIT SERIE DIN S AVEC JOINT / CONE 24° (SUITE)

O ring straight metric female 24° cone type

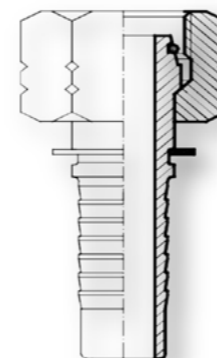

DN	Tuyau	Filetage	Code origine	Référence origine
12	1/2	22X150	040 340 220	ES13ETCO14S
12	1/2	24X150	040 340 230	ES13ETCO16S
12	1/2	30X200	040 340 240	ES13ETCO20S
16	5/8	24X150	040 340 250	ES16ETCO16S
16	5/8	30X200	040 340 260	ES16ETCO20S
20	3/4	30X200	040 340 270	ES19ETCO20S
20	3/4	36X200	040 340 280	ES19ETCO25S
25	1	36X200	040 340 290	ES25ETCO25S
25	1	42X200	040 340 300	ES25ETCO30S
32	1 1/4	42X200	040 340 310	ES32ETCO30S
32	1 1/4	52X200	040 340 320	ES32ETCO38S
40	1 1/2	52X200	040 340 330	ES38ETCO38S

## EMBOUT FEMELLE SERIE DIN S AVEC JOINT COUDE 90° / CONE 24

F90° O ring metric female swept elbow 24° Cone S type

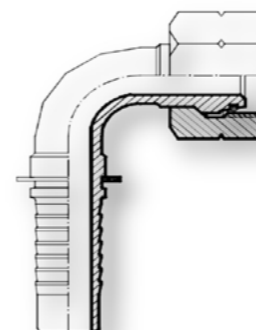

DN	Tuyau	Filetage	Code origine	Référence origine
5	3/16	14X150	040 350 100	ES04ETCO06S90
5	3/16	16X150	040 350 110	ES04ETCO08S90
6	1/4	14X150	040 350 120	ES06ETCO06S90
6	1/4	16X150	040 350 130	ES06ETCO08S90
6	1/4	18X150	040 350 140	ES06ETCO10S90
6	1/4	20X150	040 350 150	ES06ETCO12S90
8	5/16	18X150	040 350 160	ES08ETCO10S90
8	5/16	20X150	040 350 170	ES08ETCO12S90
10	3/8	18X150	040 350 180	ES10ETCO10S90
10	3/8	20X150	040 350 190	ES10ETCO12S90
10	3/8	22X150	040 350 200	ES10ETCO14S90
10	3/8	24X150	040 350 210	ES10ETCO16S90
12	1/2	22X150	040 350 220	ES13ETCO14S90
12	1/2	24X150	040 350 230	ES13ETCO16S90
12	1/2	30X200	040 350 240	ES13ETCO20S90
16	5/8	30X200	040 350 250	ES16ETCO20S90
20	3/4	30X200	040 350 260	ES19ETCO20S90
20	3/4	36X200	040 350 270	ES19ETCO25S90
25	1	36X200	040 350 280	ES25ETCO25S90
25	1	42X200	040 350 290	ES25ETCO30S90
32	1 1/4	42X200	040 350 300	ES32ETCO30S90
32	1 1/4	52X200	040 350 310	ES32ETCO38S90
40	1 1/2	52X200	040 350 320	ES38ETCO38S90



## EMBOUT FEMELLE SERIE DIN S AVEC JOINT COUDE 45° / CONE 24

45° O ring metric female swept elbow 24° cone S type

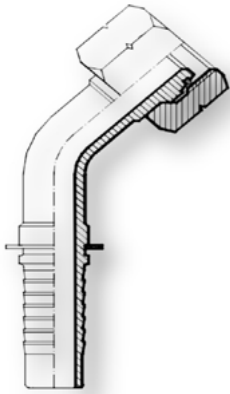

DN	Tuyau	Filetage	Code origine	Référence origine
5	3/16	14X150	040 360 100	ES04ETCO06S45
5	3/16	16X150	040 360 110	ES04ETCO08S45
6	1/4	14X150	040 360 120	ES06ETCO06S45
6	1/4	16X150	040 360 130	ES06ETCO08S45
6	1/4	18X150	040 360 140	ES06ETCO10S45
6	1/4	20X150	040 360 150	ES06ETCO12S45
8	5/16	18X150	040 360 160	ES08ETCO10S45
8	5/16	20X150	040 360 170	ES08ETCO12S45
10	3/8	18X150	040 360 180	ES10ETCO10S45
10	3/8	20X150	040 360 190	ES10ETCO12S45
10	3/8	22X150	040 360 200	ES10ETCO14S45
13	1/2	22X150	040 360 210	ES13ETCO14S45
12	1/2	24X150	040 360 220	ES13ETCO16S45
16	5/8	30X200	040 360 230	ES16ETCO20S45
20	3/4	30X200	040 360 240	ES19ETCO20S45
20	3/4	36X200	040 360 250	ES19ETCO25S45
25	1	36X200	040 360 260	ES25ETCO25S45
25	1	42X200	040 360 270	ES25ETCO30S45
32	1 1/4	42X200	040 360 280	ES32ETCO30S45
32	1 1/4	52X200	040 360 290	ES32ETCO38S45
40	1 1/2	52X200	040 360 300	ES38ETCO38S45



## EMBOUTS / SÉRIE GAZ FRANÇAISE



### EMBOUT MALE GAZ SERIE FRANCAISE / CONE 24°

Metric male 24° cone french type

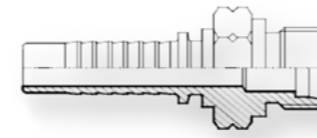

DN	Tuyau	Filetage	Code origine	Référence origine
6	1/4	20X150	040 560 100	ES06EM13
8	5/16	20X150	040 560 110	ES08EM13
10	3/8	20X150	040 560 120	ES10EM13
10	3/8	24X150	040 560 130	ES10EM17
12	1/2	24X150	040 560 140	ES13EM17
12	1/2	30X150	040 560 150	ES13EM21
16	5/8	30X150	040 560 160	ES16EM21
20	3/4	36X150	040 560 170	ES19EM27
25	1	45X150	040 560 180	ES25EM33

### EMBOUT FEMELLE DROIT GAZ SERIE FRANCAISE / CONE 24°

Straight metric female 24° cone french type

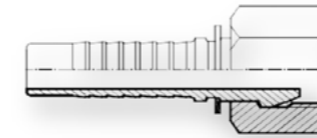

DN	Tuyau	Filetage	Code origine	Référence origine
6	1/4	20X150	040 570 100	ES06ETC13
8	5/16	20X150	040 570 110	ES08ETC13
10	3/8	20X150	040 570 120	ES10ETC13
10	3/8	24X150	040 570 130	ES10ETC17
12	1/2	20X150	040 570 135	ES13ETC13
12	1/2	24X150	040 570 140	ES13ETC17
12	1/2	30X150	040 570 150	ES13ETC21
16	5/8	30X150	040 570 160	ES16ETC21
20	3/4	30X150	040 570 170	ES19ETC21
20	3/4	36X150	040 570 180	ES19ETC27
25	1	45X150	040 570 190	ES25ETC33





## EMBOUS FEMELLE GAZ SERIE FRANCAISE COUDE 90° / CONE 24°

90° Metric female swept elbow 24° cone french type

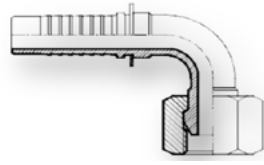

DN	Tuyau	Filetage	Code origine	Référence origine
6	1/4	20X150	040 580 100	ES06ETC13-90
8	5/16	20X150	040 580 110	ES08ETC13-90
10	3/8	20X150	040 580 120	ES10ETC13-90
10	3/8	24X150	040 580 130	ES10ETC17-90
12	1/2	24X150	040 580 140	ES13ETC17-90
16	5/8	30X150	040 580 150	ES16ETC21-90
20	3/4	36X150	040 580 160	ES19ETC27-90
25	1	45X150	040 580 170	ES25ETC33-90

## EMBOUS FEMELLE GAZ SERIE FRANCAISE COUDE 45° / CONE 24°

45° Metric female swept elbow 24° cone french type

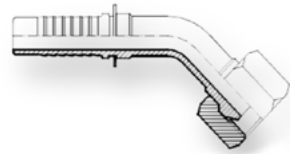

DN	Tuyau	Filetage	Code origine	Référence origine
6	1/4	20X150	040 590 100	ES06ETC13-45
8	5/16	20X150	040 590 110	ES08ETC13-45
10	3/8	20X150	040 590 120	ES10ETC13-45
10	3/8	24X150	040 590 130	ES10ETC17-45
12	1/2	24X150	040 590 140	ES13ETC17-45
16	5/8	30X150	040 590 150	ES16ETC21-45
20	3/4	36X150	040 590 160	ES19ETC27-45
25	1	45X150	040 590 170	ES25ETC33-45

## EMBOUS MALE JIC / CONE 74°

JIC male 74° cone

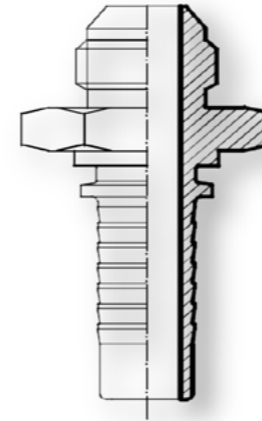

Une demande spécifique ?  
contactez-nous



[www.pm-didot.fr](http://www.pm-didot.fr)

DN	Tuyau	Filetage	Code origine	Référence origine
5	3/16	7/16 UNF	040 370 100	ES04MJ7/16
5	3/16	1/2 UNF	040 370 110	ES04MJ1/2
6	1/4	7/16 UNF	040 370 120	ES06MJ7/16
6	1/4	1/2 UNF	040 370 130	ES06MJ1/2
6	1/4	9/16 UNF	040 370 140	ES06MJ9/16
8	5/16	1/2 UNF	040 370 150	ES08MJ1/2
8	5/16	9/16 UNF	040 370 160	ES08MJ9/16
8	5/16	5/8 UNF	040 370 170	ES08MJ5/8
8	5/16	3/4 UNF	040 370 180	ES08MJ3/4
10	3/8	9/16 UNF	040 370 190	ES10MJ9/16
10	3/8	5/8 UNF	040 370 200	ES10MJ5/8
10	3/8	3/4 UNF	040 370 210	ES10MJ3/4
10	3/8	7/8 UNF	040 370 220	ES10MJ7/8
12	1/2	3/4 UNF	040 370 230	ES13MJ3/4
12	1/2	7/8 UNF	040 370 240	ES13MJ7/8
12	1/2	1 1/16 UNF	040 370 250	ES13MJ1 1/16
16	5/8	7/8 UNF	040 370 260	ES16MJ7/8
16	5/8	1 1/16 UNF	040 370 270	ES16MJ1 1/16
20	3/4	7/8 UNF	040 370 280	ES19MJ7/8
20	3/4	1 1/16 UNF	040 370 290	ES19MJ1 1/16
20	3/4	1 3/16 UNF	040 370 300	ES19MJ1 3/16
20	3/4	1 5/16 UNF	040 370 310	ES19MJ1 5/16
25	1	1 1/16 UNF	040 370 320	ES25MJ1 1/16
25	1	1 5/16 UNF	040 370 330	ES25MJ1 5/16
25	1	1 5/8 UNF	040 370 340	ES25MJ1 5/8
32	1 1/4	1 5/8 UNF	040 370 350	ES32MJ1 5/8
32	1 1/4	1 7/8 UNF	040 370 360	ES32MJ1 7/8
40	1 1/2	1 7/8 UNF	040 370 370	ES38MJ1 7/8
50	2	2 1/2 UNF	040 370 380	ES50MJ2 1/2

## EMBOUS FEMELLE DROIT JIC / CONE 74°

JIC straight female 74° cone

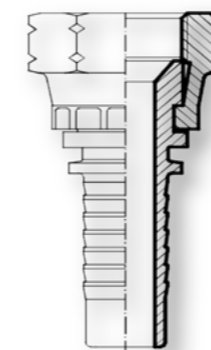

DN	Tuyau	Filetage	Code origine	Référence origine
5	3/16	7/16 UNF	040 380 100	ES04FJ7/16
5	3/16	1/2 UNF	040 380 110	ES04FJ1/2
6	1/4	7/16 UNF	040 380 120	ES06FJ7/16
6	1/4	1/2 UNF	040 380 130	ES06FJ1/2
6	1/4	9/16 UNF	040 380 140	ES06FJ9/16
6	1/4	3/4 UNF	040 380 150	ES06FJ3/4
8	5/16	1/2 UNF	040 380 160	ES08FJ1/2
8	5/16	9/16 UNF	040 380 170	ES08FJ9/16
8	5/16	5/8 UNF	040 380 180	ES08FJ5/8
8	5/16	3/4 UNF	040 380 190	ES08FJ3/4



## EMBOUT FEMELLE DROIT JIC / CONE 74° (SUITE)

JIC straight female 74° cone

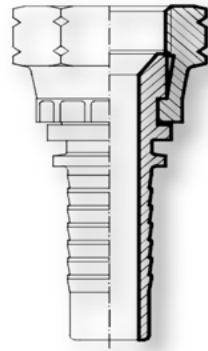

DN	Tuyau	Filetage	Code origine	Référence origine
10	3/8	9/16 UNF	040 380 200	ES10FJ9/16
10	3/8	5/8 UNF	040 380 210	ES10FJ5/8
10	3/8	3/4 UNF	040 380 220	ES10FJ3/4
10	3/8	7/8 UNF	040 380 230	ES10FJ7/8
12	1/2	9/16 UNF	040 380 240	ES13FJ9/16
12	1/2	3/4 UNF	040 380 250	ES13FJ3/4
12	1/2	7/8 UNF	040 380 260	ES13FJ7/8
12	1/2	1 1/16 UNF	040 380 270	ES13FJ1 1/16
16	5/8	7/8 UNF	040 380 280	ES16FJ7/8
16	5/8	1 1/16 UNF	040 380 290	ES16FJ1 1/16
20	3/4	7/8 UNF	040 380 300	ES19FJ7/8
20	3/4	1 1/16 UNF	040 380 310	ES19FJ1 1/16
20	3/4	1 3/16 UNF	040 380 320	ES19FJ1 3/16
20	3/4	1 5/16 UNF	040 380 330	ES19FJ1 5/16
25	1	1 1/16 UNF	040 380 340	ES25FJ1 1/16
25	1	1 5/16 UNF	040 380 350	ES25FJ1 5/16
25	1	1 5/8 UNF	040 380 360	ES25FJ1 5/8
32	1 1/4	1 5/16 UNF	040 380 370	ES32FJ1 5/16
32	1 1/4	1 5/8 UNF	040 380 380	ES32FJ1 5/8
32	1 1/4	1 7/8 UNF	040 380 390	ES32FJ1 7/8
40	1 1/2	1 7/8 UNF	040 380 400	ES38FJ1 7/8
40	1 1/2	2 1/2 UNF	040 380 410	ES38FJ2 1/2
50	2	2 1/2 UNF	040 380 420	ES50FJ2 1/2



## EMBOUT FEMELLE JIC COUDE 90° / CONE 74°

90° JIC female swept elbow 74° cone

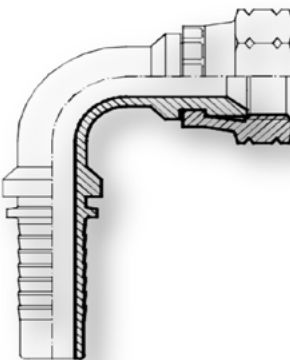

DN	Tuyau	Filetage	Code origine	Référence origine
5	3/16	7/16 UNF	040 400 100	ES04FJ7/16-90
5	3/16	1/2 UNF	040 400 110	ES04FJ1/2-90
6	1/4	7/16 UNF	040 400 120	ES06FJ7/16-90
6	1/4	1/2 UNF	040 400 130	ES06FJ1/2-90
6	1/4	9/16 UNF	040 400 140	ES06FJ9/16-90
8	5/16	1/2 UNF	040 400 150	ES08FJ1/2-90
8	5/16	9/16 UNF	040 400 160	ES08FJ9/16-90
8	5/16	5/8 UNF	040 400 170	ES08FJ5/8-90
8	5/16	3/4 UNF	040 400 180	ES08FJ3/4-90
10	3/8	9/16 UNF	040 400 190	ES10FJ9/16-90
10	3/8	5/8 UNF	040 400 200	ES10FJ5/8-90
10	3/8	3/4 UNF	040 400 210	ES10FJ3/4-90
10	3/8	7/8 UNF	040 400 220	ES10FJ7/8-90
12	1/2	3/4 UNF	040 400 230	ES13FJ3/4-90
12	1/2	7/8 UNF	040 400 240	ES13FJ7/8-90
12	1/2	1 1/16 UNF	040 400 250	ES13FJ1 1/16-90
16	5/8	7/8 UNF	040 400 260	ES16FJ7/8-90
16	5/8	1 1/16 UNF	040 400 270	ES16FJ1 1/16-90



## EMBOUT FEMELLE JIC COUDE 90° / CONE 74° (SUITE)

90° JIC female swept elbow 74° cone

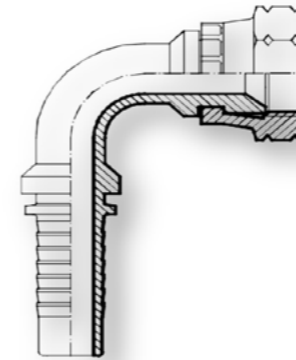

DN	Tuyau	Filetage	Code origine	Référence origine
20	3/4	7/8 UNF	040 400 280	ES19FJ7/8-90
20	3/4	1 1/16 UNF	040 400 290	ES19FJ1 1/16-90
20	3/4	1 3/16 UNF	040 400 300	ES19FJ1 3/16-90
20	3/4	1 5/16 UNF	040 400 310	ES19FJ1 5/16-90
25	1	1 1/16 UNF	040 400 320	ES25FJ1 1/16-90
25	1	1 5/16 UNF	040 400 330	ES25FJ1 5/16-90
25	1	1 5/8 UNF	040 400 340	ES25FJ1 5/8-90
32	1 1/4	1 5/8 UNF	040 400 350	ES32FJ1 5/8-90
32	1 1/4	1 7/8 UNF	040 400 360	ES32FJ1 7/8-90
40	1 1/2	1 7/8 UNF	040 400 370	ES38FJ1 7/8-90
40	1 1/2	2 1/2 UNF	040 400 380	ES38FJ2 1/2-90
50	2	2 1/2 UNF	040 400 390	ES50FJ2 1/2-90

## EMBOUT FEMELLE JIC COUDE 45° / CONE 74°

45° JIC female swept elbow 74° cone

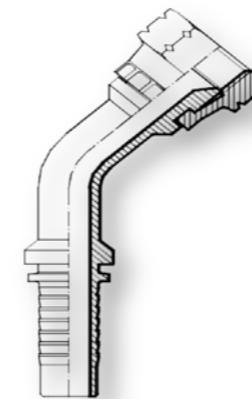

DN	Tuyau	Filetage	Code origine	Référence origine
5	3/16	7/16 UNF	040 410 100	ES04FJ7/16-45
5	3/16	1/2 UNF	040 410 110	ES04FJ1/2-45
6	1/4	7/16 UNF	040 410 120	ES06FJ7/16-45
6	1/4	1/2 UNF	040 410 130	ES06FJ1/2-45
6	1/4	9/16 UNF	040 410 140	ES06FJ9/16-45
8	5/16	1/2 UNF	040 410 150	ES08FJ1/2-45
8	5/16	9/16 UNF	040 410 160	ES08FJ9/16-45
8	5/16	5/8 UNF	040 410 170	ES08FJ5/8-45
8	5/16	3/4 UNF	040 410 180	ES08FJ3/4-45
10	3/8	9/16 UNF	040 410 190	ES10FJ9/16-45
10	3/8	5/8 UNF	040 410 200	ES10FJ5/8-45
10	3/8	3/4 UNF	040 410 210	ES10FJ3/4-45
10	3/8	7/8 UNF	040 410 220	ES10FJ7/8-45
12	1/2	3/4 UNF	040 410 230	ES13FJ3/4-45
12	1/2	7/8 UNF	040 410 240	ES13FJ7/8-45
12	1/2	1 1/16 UNF	040 410 250	ES13FJ1 1/16-45
16	5/8	7/8 UNF	040 410 260	ES16FJ7/8-45
16	5/8	1 1/16 UNF	040 410 270	ES16FJ1 1/16-45
20	3/4	7/8 UNF	040 410 280	ES19FJ7/8-45
20	3/4	1 1/16 UNF	040 410 290	ES19FJ1 1/16-45
20	3/4	1 3/16 UNF	040 410 300	ES19FJ1 3/16-45
20	3/4	1 5/16 UNF	040 410 310	ES19FJ1 5/16-45
25	1	1 1/16 UNF	040 410 320	ES25FJ1 1/16-45
25	1	1 5/16 UNF	040 410 330	ES25FJ1 5/16-45
25	1	1 5/8 UNF	040 410 340	ES25FJ1 5/8-45
32	1 1/4	1 5/8 UNF	040 410 350	ES32FJ1 5/8-45
32	1 1/4	1 7/8 UNF	040 410 360	ES32FJ1 7/8-45
40	1 1/2	1 7/8 UNF	040 410 370	ES38FJ1 7/8-45
40	1 1/2	2 1/2 UNF	040 410 380	ES38FJ2 1/2-45
50	2	2 1/2 UNF	040 410 390	ES50FJ2 1/2-45

Une demande spécifique ?  
contactez-nous



[www.pm-didot.fr](http://www.pm-didot.fr)



# EMBOUTS / SÉRIE ORFS



## EMBOUT MALE ORFS

ORFS male

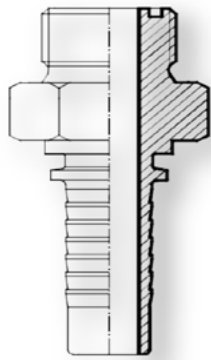

DN	Tuyau	Filetage	Code origine	Référence origine
6	1/4	9/16 UNF	040 430 100	ES06MORFS9/16
6	1/4	11/16 UNF	040 430 110	ES06MORFS11/16
8	5/16	11/16 UNF	040 430 120	ES08MORFS11/16
10	3/8	11/16 UNF	040 430 130	ES10MORFS11/16
10	3/8	13/16 UNF	040 430 140	ES10MORFS13/16
10	3/8	1 UNF	040 430 150	ES10MORFS1
12	1/2	13/16 UNF	040 430 160	ES13MORFS13/16
12	1/2	1 UNF	040 430 170	ES13MORFS1
12	1/2	1 3/16 UNF	040 430 180	ES13MORFS1 3/16
16	5/8	1 UNF	040 430 190	ES16MORFS1
16	5/8	1 3/16 UNF	040 430 200	ES16MORFS1 3/16
20	3/4	1 3/16 UNF	040 430 210	ES19MORFS1 3/16
20	3/4	1 7/16 UNF	040 430 220	ES19MORFS1 7/16
25	1	1 7/16 UNF	040 430 230	ES25MORFS1 7/16
25	1	1 11/16 UNF	040 430 231	ES25MORFS1 11/16
32	1 1/4	1 11/16 UNF	040 430 240	ES32MORFS1 11/16
40	1 1/2	2 1/2 UNF	040 430 250	ES38MORFS2 1/2

## EMBOUT FEMELLE DROIT ORFS

Straight ORFS female

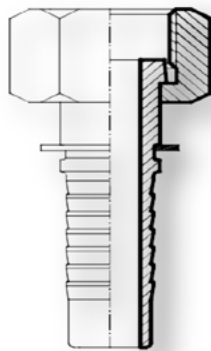

DN	Tuyau	Filetage	Code origine	Référence origine
6	1/4	9/16 UNF	040 440 100	ES06ORFS9/16
6	1/4	11/16 UNF	040 440 110	ES06ORFS11/16
8	5/16	9/16 UNF	040 440 120	ES08ORFS9/16
8	5/16	11/16 UNF	040 440 130	ES08ORFS11/16
10	3/8	9/16 UNF	040 440 140	ES10ORFS9/16
10	3/8	11/16 UNF	040 440 150	ES10ORFS11/16
10	3/8	13/16 UNF	040 440 160	ES10ORFS13/16
12	1/2	13/16 UNF	040 440 170	ES13ORFS13/16
12	1/2	1 UNF	040 440 180	ES13ORFS1
12	1/2	1 3/16 UNF	040 440 190	ES13ORFS1 3/16
16	5/8	1 UNF	040 440 200	ES16ORFS1
16	5/8	1 3/16 UNF	040 440 210	ES16ORFS1 3/16
20	3/4	1 3/16 UNF	040 440 220	ES19ORFS1 3/16
20	3/4	1 7/16 UNF	040 440 230	ES19ORFS1 7/16
25	1	1 7/16 UNF	040 440 240	ES25ORFS1 7/16
25	1	1 11/16 UNF	040 440 250	ES25ORFS1 11/16
32	1 1/4	1 11/16 UNF	040 440 260	ES32ORFS1 11/16
40	1 1/2	2 1/2 UNF	040 440 270	ES38ORFS2

## EMBOUT FEMELLE ORFS COUDE 90°

90° ORFS female

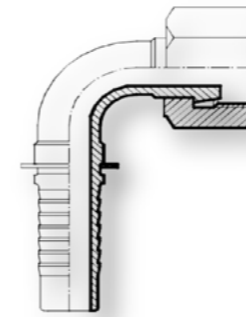

DN	Tuyau	Filetage	Code origine	Référence origine
6	1/4	9/16 UNF	040 450 100	ES06ORFS9/16-90
6	1/4	11/16 UNF	040 450 110	ES06ORFS11/16-90
8	5/16	9/16 UNF	040 450 120	ES08ORFS9/16-90
8	5/16	11/16 UNF	040 450 130	ES08ORFS11/16-90
10	3/8	9/16 UNF	040 450 140	ES10ORFS9/16-90
10	3/8	11/16 UNF	040 450 150	ES10ORFS11/16-90
10	3/8	13/16 UNF	040 450 160	ES10ORFS13/16-90
12	1/2	13/16 UNF	040 450 170	ES13ORFS13/16-90
12	1/2	1 UNF	040 450 180	ES13ORFS1-90
12	1/2	1 3/16 UNF	040 450 190	ES13ORFS1 3/16-90
16	5/8	1 UNF	040 450 200	ES16ORFS1-90
16	5/8	1 3/16 UNF	040 450 210	ES16ORFS1 3/16-90
20	3/4	1 3/16 UNF	040 450 220	ES19ORFS1 3/16-90
20	3/4	1 7/16 UNF	040 450 230	ES19ORFS1 7/16-90
25	1	1 7/16 UNF	040 450 240	ES25ORFS1 7/16-90
25	1	1 11/16 UNF	040 450 250	ES25ORFS1 11/16-90
32	1 1/4	1 11/16 UNF	040 450 260	ES32ORFS1 11/16-90
40	1 1/2	2 1/2 UNF	040 450 270	ES38ORFS2-90

## EMBOUT FEMELLE ORFS COUDE 45°

45° ORFS female

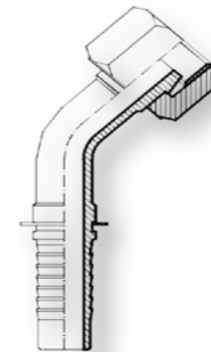

DN	Tuyau	Filetage	Code origine	Référence origine
6	1/4	9/16 UNF	040 460 100	ES06ORFS9/16-45
6	1/4	11/16 UNF	040 460 110	ES06ORFS11/16-45
8	5/16	9/16 UNF	040 460 120	ES08ORFS9/16-45
8	5/16	11/16 UNF	040 460 130	ES08ORFS11/16-45
10	3/8	9/16 UNF	040 460 140	ES10ORFS9/16-45
10	3/8	11/16 UNF	040 460 150	ES10ORFS11/16-45
10	3/8	13/16 UNF	040 460 160	ES10ORFS13/16-45
12	1/2	13/16 UNF	040 460 170	ES13ORFS13/16-45
12	1/2	1 UNF	040 460 180	ES13ORFS1-45
12	1/2	1 3/16 UNF	040 460 190	ES13ORFS1 3/16-45
16	5/8	1 UNF	040 460 200	ES16ORFS1-45
16	5/8	1 3/16 UNF	040 460 210	ES16ORFS1 3/16-45
20	3/4	1 3/16 UNF	040 460 220	ES19ORFS1 3/16-45
20	3/4	1 7/16 UNF	040 460 230	ES19ORFS1 7/16-45
25	1	1 7/16 UNF	040 460 240	ES25ORFS1 7/16-45
32	1 1/4	1 11/16 UNF	040 460 250	ES25ORFS1 11/16-45
32	1 1/4	1 11/16 UNF	040 460 260	ES32ORFS1 11/16-45
40	1 1/2	2 1/2 UNF	040 460 270	ES38ORFS2 1/2-45

Une demande spécifique ?  
contactez-nous



[www.pm-didot.fr](http://www.pm-didot.fr)



# EMBOUTS / DOUBLE JONCTION

## EMBOUT JONCTION DROIT

Double connector



DN	Tuyau	Filetage	Code origine	Référence origine
6	1/4		040 280 100	ES06ER
8	5/16		040 280 110	ES08ER
10	3/8		040 280 120	ES10ER
12	1/2		040 280 130	ES13ER
16	5/8		040 280 140	ES16ER
20	3/4		040 280 150	ES19ER
25	1		040 280 160	ES25ER
32	1 1/4		040 280 170	ES32ER

# EMBOUTS / LAVEUR HP

## EMBOUT LAVEUR HAUTE PRESSION

Female fitting for high pressure water jet cleaner

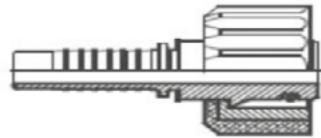

DN	Tuyau	Filetage	Code origine	Référence origine
6	1/4	22X150	040 480 100	ES06ETK22
6	1/4	22X150	040 480 110	ES06ETK22/15
8	5/16	22X150	040 480 120	ES08ETK22
8	5/16	22X150	040 480 130	ES08ETK22/15
10	3/8	22X150	040 480 140	ES10ETK22
10	3/8	22X150	040 480 150	ES10ETK22/15

## EMBOUT MALE LAVEUR HAUTE PRESSION POUR POIGNEE PISTO

Male fitting for high pressure water jet cleaner

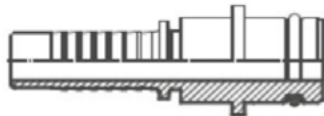

DN	Tuyau	Filetage	Code origine	Référence origine
6	1/4	T10	040 490 100	ES06ELK10
6	1/4	T11	040 490 110	ES06ELK11
8	5/16	T10	040 490 120	ES08ELK10
8	5/16	T11	040 490 130	ES08ELK11

# VALVES AGRICOLES

## EMBOUT VALVE AGRICOLE MALE

Agriculture male fitting



DN	Tuyau	Filetage	Code origine	Référence origine
4	1/4	18X150	040 700 100	ES06MAV18
5	5/16	18X150	040 700 110	ES08MAV18
6	3/8	18X150	040 700 120	ES10MAV18
8	1/2	18X150	040 700 130	ES13MAV18

# BAGUES / ÉCROUS SÉRIE DIN L ET S



## BAGUE SERIE 24° DIN L / S

Double cutting ring



FILETAGE A	FILETAGE B	FILETAGE C	Code origine	Référence origine
			090100100	B04LL
			090100110	B06L/S
			090100120	B06LL
			090100130	B08L/S
			090100140	B08LL
			090100150	B10L/S
			090100160	B12L/S
			090100170	B15L
			090100180	B18L
			090100190	B22L
			090100200	B28L
			090100210	B35L
			090100220	B42L
			090100230	B14S
			090100240	B16S
			090100250	B20S
			090100260	B25S
			090100270	B30S
			090100280	B38S

## ECROU SERIE 24° DIN L / S

NUT DIN 3870



FILETAGE A	FILETAGE B	FILETAGE C	Code origine	Référence origine
8X100			090105100	E04LL
12X150			090105110	E06L
10X100			090105120	E06LL
14X150			090105130	E08L
12X100			090105140	E08LL
16X150			090105150	E10L
18X150			090105160	E12L
22X150			090105170	E15L
26X150			090105180	E18L
30X200			090105190	E22L
36X200			090105200	E28L
45X200			090105210	E35L
52X200			090105220	E42L
14X150			090105230	E06S
16X150			090105240	E08S
18X150			090105250	E10S
20X150			090105260	E12S
22X150			090105270	E14S
24X150			090105280	E16S
30X200			090105290	E20S
36X200			090105300	E25S
42X200			090105310	E30S
52X200			090105320	E38S



# ÉCROUS/BAGUES SÉRIE GAZ FRANÇAIS



## BAGUE SERIE GAZ

Double cutting ring



A	Filetage		Code origine	Référence origine
	B	C		
			150 100 190	BAG13
			150 100 195	BAG17
			150 100 200	BAG21
			150 100 205	BAG27
			150 100 210	BAG33

## ECROU SERIE GAZ

Nut gas serie



A	Filetage		Code origine	Référence origine
	B	C		
20X150			150 100 215	ECG13
24X150			150 100 220	ECG17
30X150			150 100 225	ECG21
36X150			150 100 230	ECG27
45X150			150 100 235	ECG33



# RACCORDS UNION DOUBLE ET ADAPTATEURS SÉRIE DIN L ET S



## UNION MALE DIN 24° SERIE L/S - MALE GAZ CYLINDRIQUE JOINT ENCASTRE

Male stud coupling rubber seal form E Din 3852



DN	Tuyau	Filetage	Code origine	Référence origine
8X100	1/8CYL		090 110 100	UM04L1/8CYL
12X150	1/8CYL		090 110 110	UM06L1/8CYL
10X100	1/8CYL		090 110 120	UM06L1/8CYL
12X150	1/4CYL		090 110 130	UM06L1/4CYL
12X150	3/8CYL		090 110 140	UM06L3/8CYL
14X150	1/8CYL		090 110 150	UM08L1/8CYL
14X150	1/4CYL		090 110 160	UM08L1/4CYL
14X150	3/8CYL		090 110 170	UM08L3/8CYL
14X150	1/2CYL		090 110 180	UM08L1/2CYL
16X150	1/8CYL		090 110 190	UM10L1/8CYL
16X150	1/4CYL		090 110 200	UM10L1/4CYL
16X150	3/8CYL		090 110 210	UM10L3/8CYL
16X150	1/2CYL		090 110 220	UM10L1/2CYL
18X150	1/4CYL		090 110 230	UM12L1/4CYL
18X150	3/8CYL		090 110 240	UM12L3/8CYL
18X150	1/2CYL		090 110 250	UM12L1/2CYL
18X150	3/4CYL		090 110 260	UM12L3/4CYL
18X150	1CYL		090 110 270	UM12L1CYL
22X150	3/8CYL		090 110 280	UM15L3/8CYL
22X150	1/2CYL		090 110 290	UM15L1/2CYL
22X150	3/4CYL		090 110 300	UM15L3/4CYL
26X150	1/2CYL		090 110 310	UM18L1/2CYL
26X150	3/4CYL		090 110 320	UM18L3/4CYL
30X200	1/2CYL		090 110 330	UM22L1/2CYL
30X200	3/4CYL		090 110 340	UM22L3/4CYL
30X200	1CYL		090 110 350	UM22L1CYL
36X200	3/4CYL		090 110 360	UM28L3/4CYL
36X200	1CYL		090 110 370	UM28L1CYL
45X200	1CYL		090 110 380	UM35L1CYL
45X200	1 1/4CYL		090 110 390	UM35L1 1/4CYL
52X200	1 1/4CYL		090 110 400	UM42L1 1/4CYL
52X200	1 1/2CYL		090 110 410	UM42L1 1/2CYL

Une demande spécifique ?  
contactez-nous



[www.pm-didot.fr](http://www.pm-didot.fr)



## UNION MALE DIN 24° SERIE L/S - MALE METRIQUE CONE 60° JOINT ENCASTRE

Metric male stud coupling rubber seal form E din 3852



Filetage			Code origine	Référence origine
A	B	C		
8X100	8X100		090 120 100	UM04LL8x100
12X150	10X100		090 120 110	UM06L10x100
14X150	10X100		090 120 120	UM08LL10x100
14X150	12X150		090 120 130	UM08L12x150
14X150	18X150		090 120 140	UM08L18x150
16X150	12X150		090 120 150	UM10L12x150
16X150	14X150		090 120 160	UM10L14x150
16X150	16X150		090 120 170	UM10L16x150
16X150	18X150		090 120 180	UM10L18x150
16X150	22X150		090 120 190	UM10L22x150
18X150	14X150		090 120 200	UM12L14x150
18X150	16X150		090 120 210	UM12L16x150
18X150	18X150		090 120 220	UM12L18x150
18X150	22X150		090 120 230	UM12L22x150
22X150	16X150		090 120 240	UM15L16x150
22X150	18X150		090 120 250	UM15L18x150
22X150	22X150		090 120 260	UM15L22x150
26X150	18X150		090 120 270	UM18L18x150
26X150	22X150		090 120 280	UM18L22x150
30X200	22X150		090 120 290	UM22L22x150
30X200	26X150		090 120 300	UM22L26x150
36X200	33X200		090 120 310	UM28L33x200
45X200	42X200		090 120 320	UM35L42x200
52X200	48X200		090 120 330	UM42L48x200
14X150	12X150		090 120 340	UM06S12x150
16X150	14X150		090 120 350	UM08S14x150
18X150	16X150		090 120 360	UM10S16x150
20X150	18X150		090 120 370	UM12S18x150
20X150	22X150		090 120 380	UM12S22x150
22X150	20X150		090 120 390	UM14S20x150
24X150	18X150		090 120 400	UM16S18x150
24X150	22X150		090 120 410	UM16S22x150
30X200	22X150		090 120 420	UM20S22x150
30X200	27X200		090 120 430	UM20S27x200
36X200	27X200		090 120 440	UM25S27x200
36X200	33X200		090 120 450	UM25S33x200
42X200	42X200		090 120 460	UM30S42x200
52X200	48X200		090 120 470	UM38S48x200



## UNION MALE DIN 24° SERIE L/S - MALE GAZ CONIQUE

BSPT male stud coupling



Filetage			Code origine	Référence origine
A	B	C		
12X150	1/8		090 130 100	UM06L1/8CO
12X150	1/4		090 130 110	UM06L1/4CO
14X150	1/8		090 130 120	UM08L1/8CO
14X150	1/4		090 130 130	UM08L1/4CO
14X150	3/8		090 130 140	UM08L3/8CO

## UNION MALE DIN 24° SERIE L/S - MALE GAZ CONIQUE (SUITE)

BSPT male stud coupling



Filetage			Code origine	Référence origine
A	B	C		
14X150	1/2		090 130 145	UM08L1/2CO
16X150	1/8		090 130 150	UM10L1/8CO
16X150	1/4		090 130 160	UM10L1/4CO
16X150	3/8		090 130 170	UM10L3/8CO
16X150	1/2		090 130 180	UM10L1/2CO
18X150	1/4		090 130 190	UM12L1/4CO
18X150	3/8		090 130 200	UM12L3/8CO
18X150	1/2		090 130 210	UM12L1/2CO
22X150	3/8		090 130 220	UM15L3/8CO
22X150	1/2		090 130 230	UM15L1/2CO
26X150	3/8		090 130 240	UM18L3/8CO
26X150	1/2		090 130 250	UM18L1/2CO
26X150	3/4		090 130 260	UM18L3/4CO
30X200	3/4		090 130 270	UM22L3/4CO
36X200	1		090 130 280	UM28L1CO
45X200	1 1/4		090 130 290	UM35L1 1/4CO
52X200	1 1/2		090 130 300	UM42L1 1/2CO
14X150	1/4		090 130 310	UM06S1/4CO
16X150	1/4		090 130 320	UM08S1/4CO
18X150	1/4		090 130 330	UM10S1/4CO
18X150	3/8		090 130 340	UM10S3/8CO
20X150	1/4		090 130 350	UM12S1/4CO
20X150	3/8		090 130 360	UM12S3/8CO
20X150	1/2		090 130 370	UM12S1/2CO
22X150	3/8		090 130 380	UM14S3/8CO
22X150	1/2		090 130 390	UM14S1/2CO
24X150	3/8		090 130 400	UM16S3/8CO
24X150	1/2		090 130 410	UM16S1/2CO
30X200	1/2		090 130 420	UM20S1/2CO
30X200	3/4		090 130 430	UM20S3/4CO
36X200	3/4		090 130 440	UM25S3/4CO
36X200	1		090 130 450	UM25S1CO
42X200	1		090 130 460	UM30S1CO
42X200	1 1/4		090 130 470	UM30S1 1/4CO
52X200	1 1/2		090 130 480	UM38S1 1/2CO



Une demande spécifique ?  
contactez-nous



[www.pm-didot.fr](http://www.pm-didot.fr)



## ADAPTEUR FEMELLE DIN SERIE L/S AVEC JOINT - MALE GAZ CYLINDRIQUE JOINT ENCASTRE

Straight stud standpipe adaptor captive seal O. Ring form E din 3852

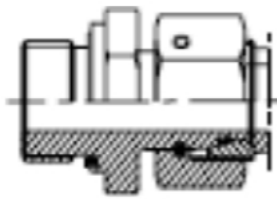

A	Filetage		Code origine	Référence origine
	B	C		
12X150	1/8CYL		090 155 100	AT06L1/8CYL
14X150	1/4CYL		090 155 110	AT08L1/4CYL
16X150	1/4CYL		090 155 120	AT10L1/4CYL
16X150	3/8CYL		090 155 130	AT10L3/8CYL
18X150	1/4CYL		090 155 140	AT12L1/4CYL
18X150	3/8CYL		090 155 150	AT12L3/8CYL
18X150	1/2CYL		090 155 160	AT12L1/2CYL
22X150	1/2CYL		090 155 170	AT15L1/2CYL
22X150	1/2CO		090 155 171	AT15L1/2CO
26X150	1/2CYL		090 155 180	AT18L1/2CYL
30X200	3/4CYL		090 155 190	AT22L3/4CYL
36X200	1CYL		090 155 200	AT28L1CYL
45X200	1 1/4CYL		090 155 210	AT35L1 1/4CYL
52X200	1 1/2CYL		090 155 220	AT42L1 1/2CYL
14X150	1/4CYL		090 155 230	AT06S1/4CYL
16X150	1/4CYL		090 155 240	AT08S1/4CYL
18X150	3/8CYL		090 155 250	AT10S3/8CYL
20X150	3/8CYL		090 155 260	AT12S3/8CYL
22X150	1/2CYL		090 155 270	AT14S1/2CYL
24X150	1/2CYL		090 155 280	AT16S1/2CYL
30X200	3/4CYL		090 155 290	AT20S3/4CYL
36X200	1CYL		090 155 300	AT25S1CYL
42X200	1 1/4CYL		090 155 310	AT30S1 1/4CYL
52X200	1 1/4CYL		090 155 320	AT38S1 1/4CYL
52X200	1 1/2CYL		090 155 330	AT38S1 1/2CYL

## UNION DOUBLE MALE SERIE DIN 24° L/S

Straight coupling 24° din



A	Filetage		Code origine	Référence origine
	B	C		
8X100	8X100		090 205 100	UD04LL EQ
12X150	12X150		090 205 110	UD06L
10X100	10X100		090 205 120	UD06LL
14X150	14X150		090 205 130	UD08L
16X150	16X150		090 205 140	UD10L
18X150	18X150		090 205 150	UD12L
22X150	22X150		090 205 160	UD15L
26X150	26X150		090 205 170	UD18L
30X200	30X200		090 205 180	UD22L
36X200	36X200		090 205 190	UD28L
45X200	45X200		090 205 200	UD35L
52X200	52X200		090 205 210	UD42L
14X150	14X150		090 205 220	UD06S
16X150	16X150		090 205 230	UD08S
18X150	18X150		090 205 240	UD10S
20X150	20X150		090 205 250	UD12S
22X150	22X150		090 205 260	UD14S
24X150	24X150		090 205 270	UD16S
30X200	30X200		090 205 280	UD20S
36X200	36X200		090 205 290	UD25S
42X200	42X200		090 205 300	UD30S
52X200	52X200		090 205 310	UD38S

## UNION DOUBLE DE REDUCTION MALE DIN 24° SERIE L/S

Reduced straight coupling din 24°



A	Filetage		Code origine	Référence origine
	B	C		
14X150	12X150		090 210 100	UDR08-06L
16X150	12X150		090 210 110	UDR10-06L
16X150	14X150		090 210 120	UDR10-08L
18X150	12X150		090 210 130	UDR12-06L
18X150	14X150		090 210 140	UDR12-08L
18X150	16X150		090 210 150	UDR12-10L
22X150	16X150		090 210 160	UDR15-10L
22X150	18X150		090 210 170	UDR15-12L
26X150	16X150		090 210 180	UDR18-10L
26X150	18X150		090 210 190	UDR18-12L
26X150	22X150		090 210 200	UDR18-15L
30X200	18X150		090 210 210	UDR22-12L
30X200	22X150		090 210 220	UDR22-15L
30X200	26X150		090 210 230	UDR22-18L
36X200	26X150		090 210 240	UDR28-18L
36X200	30X200		090 210 250	UDR28-22L
45X200	30X200		090 210 260	UDR35-22L
45X200	36X200		090 210 270	UDR35-28L
16X150	14X150		090 210 280	UDR08-06S
18X150	14X150		090 210 290	UDR10-06S
18X150	16X150		090 210 300	UDR10-08S
20X150	14X150		090 210 310	UDR12-06S
20X150	16X150		090 210 320	UDR12-08S
20X150	18X150		090 210 330	UDR12-10S
22X150	18X150		090 210 340	UDR14-10S
22X150	20X150		090 210 350	UDR14-12S
24X150	20X150		090 210 360	UDR16-12S
24X150	22X150		090 210 370	UDR16-14S
30X200	18X150		090 210 380	UDR20-10S
30X200	20X150		090 210 390	UDR20-12S
30X200	22X150		090 210 400	UDR20-14S
30X200	24X150		090 210 410	UDR20-16S
36X200	24X150		090 210 420	UDR25-16S
36X200	30X200		090 210 430	UDR25-20S
42X200	30X200		090 210 440	UDR30-20S
42X200	36X200		090 210 450	UDR30-25S
52X200	36X200		090 210 460	UDR38-25S
52X200	42X200		090 210 470	UDR38-30S

Une demande spécifique ? contactez-nous



[www.pm-didot.fr](http://www.pm-didot.fr)



# RACCORD SÉRIE GAZ FRANÇAIS

## UNIONS DOUBLES ET ADAPTATEURS

### UNION MALE SERIE GAZ-MALE GAZ CYLINDRIQUE

Male stud coupling seal form E gas serie



A	Filetage		Code origine	Référence origine
	B	C		
20X150	1/4		150 100 420	UM13G1/4CYL
20X150	3/8		150 100 430	UM13G3/8CYL
20X150	1/2		150 100 440	UM13G1/2CYL
24X150	3/8		150 100 450	UM17G3/8CYL
24X150	1/2		150 100 460	UM17G1/2CYL
30X150	1/2		150 100 470	UM21G1/2CYL
30X150	3/4		150 100 480	UM21G3/4CYL
36X150	3/4		150 100 490	UM27G3/4CYL
36X150	1		150 100 500	UM27G1CYL
45X150	1		150 100 510	UM33G1CYL
45X150	1 1/4		150 100 511	UM33G1 14CYL
52X150	1 1/4		150 100 512	UM42G1 14CYL
52X150	1 1/2		150 100 513	UM42G1 12CYL

### UNION MALE SERIE GAZ-MALE GAZ CONIQUE

BSPT male stud coupling gas serie



A	Filetage		Code origine	Référence origine
	B	C		
20X150	1/4		150 100 415	UM13G1/4CO
20X150	3/8		150 100 425	UM13G3/8CO
20X150	1/2		150 100 435	UM13G1/2CO
24X150	1/4		150 100 436	UM17G1/4CO
24X150	3/8		150 100 445	UM17G3/8CO
24X150	1/2		150 100 455	UM17G1/2CO
24X150	3/4		150 100 456	UM17G3/4CO
30X150	1/2		150 100 465	UM21G1/2CO
30X150	3/4		150 100 475	UM21G3/4CO
36X150	3/4		150 100 485	UM27G3/4CO
36X150	1		150 100 495	UM27G1CO
45X150	1		150 100 505	UM33G1CO
45X150	1 1/4		150 100 506	UM33G1 14CO
52X150	1 1/4		150 100 507	UM42G1 14CO
52X150	1 1/2		150 100 508	UM42G1 12CO

### UNION MALE SERIE GAZ-MALE METRIQUE

Metric male stud coupling rubber seal gas serie



A	Filetage		Code origine	Référence origine
	B	C		
20X150	16X150		150 100 515	UM13G16x150
20X150	18X150		150 100 520	UM13G18x150
24X150	18X150		150 100 525	UM17G18x150
24X150	20X150		150 100 526	UM17G20x150
24X150	22X150		150 100 527	UM17G22x150
30X150	22X150		150 100 530	UM21G22x150

### ADAPTATEUR FEMELLE SERIE GAZ-MALE GAZ CYLINDRIQUE

Straight stud standpipe adaptator captive seal gas serie

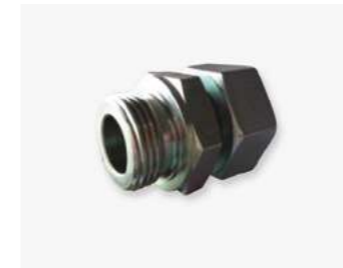

A	Filetage		Code origine	Référence origine
	B	C		
20X150	1/4		150 100 110	AT13G1/4CYL
20X150	3/8		150 100 120	AT13G3/8CYL
20X150	1/2		150 100 122	AT13G1/2CYL
24X150	3/8		150 100 130	AT17G3/8CYL
24X150	1/2		150 100 140	AT17G1/2CYL
30X150	1/2		150 100 150	AT21G1/2CYL
30X150	3/4		150 100 160	AT21G3/4CYL
36X150	3/4		150 100 170	AT27G3/4CYL
36X150	1		150 100 180	AT27G1CYL
45X150	1		150 100 185	AT33G1CYL
45X150	1 1/4		150 100 186	AT33G1 14CYL
52X150	1 1/4		150 100 187	AT42G1 1/4CYL
52X150	1 1/2		150 100 188	AT42G1 1/2CYL

### ADAPTATEUR FEMELLE SERIE GAZ-MALE GAZ CONIQUE

Straight stud standpipe adaptator BSPT gas serie



A	Filetage		Code origine	Référence origine
	B	C		
20X150	1/4		150 100 105	AT13G1/4CO
20X150	3/8		150 100 115	AT13G3/8CO
20X150	1/2		150 100 121	AT13G1/2CO
24X150	3/8		150 100 125	AT17G3/8CO
24X150	1/2		150 100 135	AT17G1/2CO
30X150	1/2		150 100 145	AT21G1/2CO
30X150	3/4		150 100 155	AT21G3/4CO
36X150	3/4		150 100 165	AT27G3/4CO
36X150	1		150 100 175	AT27G1CO
45X150	1		150 100 176	AT33G1CO

### UNION DOUBLE SERIE GAZ

Straight coupling 24° gas



A	Filetage		Code origine	Référence origine
	B	C		
20X150	20X150		150 100 390	UD13
24X150	24X150		150 100 395	UD17
30X150	30X150		150 100 400	UD21
36X150	36X150		150 100 405	UD27
45X150	45X150		150 100 410	UD33

### UNION DOUBLE DE REDUCTION SERIE GAZ

Reduced straight coupling gas serie



A	Filetage		Code origine	Référence origine
	B	C		
20X150	18X150		150 100 559	UDR13-12G
20X150	24X150		150 100 560	UDR17-13G
24X150	30X150		150 100 565	UDR21-17G
30X150	36X150		150 100 570	UDR27-21G

# COUDES / SÉRIE DIN L ET S



## COUDE MALE DIN 24° SERIE L/S - MALE GAZ CONIQUE

Stud elbow din 24° L/S serie-ale BSPT



A	Filetage		Code origine	Référence origine
	B	C		
12X150	1/8		090 260 100	CM06L1/8CO
12X150	1/4		090 260 110	CM06L1/4CO
14X150	1/8		090 260 120	CM08L1/8CO
14X150	1/4		090 260 130	CM08L1/4CO
14X150	3/8		090 260 140	CM08L3/8CO
14X150	1/2		090 260 150	CM08L1/2CO
16X150	1/8		090 260 160	CM10L1/8CO
16X150	1/4		090 260 170	CM10L1/4CO
16X150	3/8		090 260 180	CM10L3/8CO
16X150	1/2		090 260 190	CM10L1/2CO
18X150	1/4		090 260 200	CM12L1/4CO
18X150	3/8		090 260 210	CM12L3/8CO
18X150	1/2		090 260 220	CM12L1/2CO
22X150	3/8		090 260 230	CM15L3/8CO
22X150	1/2		090 260 240	CM15L1/2CO
26X150	1/2		090 260 250	CM18L1/2CO
26X150	3/4		090 260 260	CM18L3/4CO
30X200	3/4		090 260 270	CM22L3/4CO
36X200	1		090 260 280	CM28L1CO
45X200	1 1/4		090 260 290	CM35L1 1/4CO
52X200	1 1/2		090 260 300	CM42L1 1/2CO
14X150	1/4		090 260 310	CM06S1/4CO
16X150	1/4		090 260 320	CM08S1/4CO
18X150	3/8		090 260 330	CM10S3/8CO
20X150	3/8		090 260 340	CM12S3/8SO
20X150	1/2		090 260 350	CM12S1/2CO
22X150	3/8		090 260 360	CM14S3/8CO
22X150	1/2		090 260 370	CM14S1/2CO
24X150	3/8		090 260 380	CM16S3/8CO
24X150	1/2		090 260 390	CM16S1/2CO
30X200	1/2		090 260 400	CM20S1/2CO
30X200	3/4		090 260 410	CM20S3/4CO
36X200	3/4		090 260 420	CM25S3/4CO
36X200	1		090 260 430	CM25S1CO
42X200	1		090 260 440	CM30S1CO
42X200	1 1/4		090 260 450	CM30S1 1/4CO
52X200	1 1/4		090 260 460	CM38S1 1/4CO
52X200	1 1/2		090 260 470	CM38S1 1/2CO

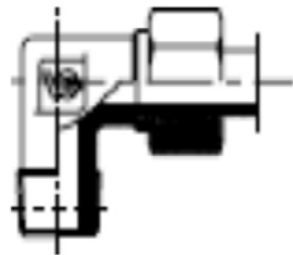

## COUDE EGAL MALE DIN 24° SERIE L/S

Equal elbow male din 24° L/S serie



A	Filetage		Code origine	Référence origine
	B	C		
8X100	8X100		090 285 100	CE04LL EQ
12X150	12X150		090 285 110	CE06L
10X100	10X100		090 285 120	CE06LL EQ
14X150	14X150		090 285 130	CE08L
12X100	12X100		090 285 140	CE08LL EQ
16X150	16X150		090 285 150	CE10L
18X150	18X150		090 285 160	CE12L
22X150	22X150		090 285 170	CE15L
26X150	26X150		090 285 180	CE18L
30X200	30X200		090 285 190	CE22L
36X200	36X200		090 285 200	CE28L
45X200	45X200		090 285 210	CE35L
52X200	52X200		090 285 220	CE42L
14X150	14X150		090 285 230	CE06S
16X150	16X150		090 285 240	CE08S
18X150	18X150		090 285 250	CE10S
20X150	20X150		090 285 260	CE12S
22X150	22X150		090 285 270	CE14S
24X150	24X150		090 285 280	CE16S
30X200	30X200		090 285 290	CE20S
36X200	36X200		090 285 300	CE25S
42X200	42X200		090 285 310	CE30S
52X200	52X200		090 285 320	CE38S



## COUDE MALE-FEMELLE DIN 24° SERIE L/S

Angular rotary fitting male-female din 24° L/S serie

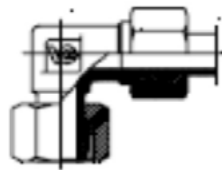

A	Filetage		Code origine	Référence origine
	B	C		
12X150	12X150		090 290 100	CF06L
14X150	14X150		090 290 110	CF08L
16X150	16X150		090 290 120	CF10L
18X150	18X150		090 290 130	CF12L
22X150	22X150		090 290 140	CF15L
26X150	26X150		090 290 150	CF18L
30X200	30X200		090 290 160	CF22L
36X200	36X200		090 290 170	CF28L
45X200	45X200		090 290 180	CF35L
52X200	52X200		090 290 190	CF42L
14X150	14X150		090 290 210	CF06S
16X150	16X150		090 290 210	CF08S
18X150	18X150		090 290 220	CF10S
20X150	20X150		090 290 230	CF12S
22X150	22X150		090 290 240	CF14S
24X150	24X150		090 290 250	CF16S
30X200	30X200		090 290 260	CF20S
36X200	36X200		090 290 270	CF25S
42X200	42X200		090 290 280	CF30S
52X200	52X200		090 290 290	CF38S

## COUDE MALE-FEMELLE-JOINT O.RING DIN 24° SERIE L/S

Angular rotary fitting O. Ring seal male-female din 24° L/S serie

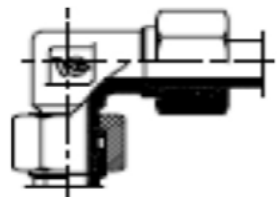

A	Filetage		Code origine	Référence origine
	B	C		
12X150	12X150		090 295 100	CFOR06L
14X150	14X150		090 295 110	CFOR08L
16X150	16X150		090 295 120	CFOR10L
18X150	18X150		090 295 130	CFOR12L
22X150	22X150		090 295 140	CFOR15L
26X150	26X150		090 295 150	CFOR18L
30X200	30X200		090 295 160	CFOR22L
36X200	36X200		090 295 170	CFOR28L
45X200	45X200		090 295 180	CFOR35L
52X200	52X200		090 295 190	CFOR42L
14X150	14X150		090 295 200	CFOR06S
16X150	16X150		090 295 210	CFOR08S
18X150	18X150		090 295 220	CFOR10S
20X150	20X150		090 295 230	CFOR12S
22X150	22X150		090 295 240	CFOR14S
24X150	24X150		090 295 250	CFOR16S
30X200	30X200		090 295 260	CFOR20S
36X200	36X200		090 295 270	CFOR25S
42X200	42X200		090 295 280	CFOR30S
52X200	52X200		090 295 290	CFOR38S

# COUDES SÉRIE GAZ FRANÇAIS



## COUDE MALE SERIE GAZ-MALE GAZ CONIQUE

Stud elbow gas serie male-male BSPT



A	Filetage		Code origine	Référence origine
	B	C		
20X150	1/4		150 100 265	CM13G1/4CO
20X150	3/8		150 100 270	CM13G3/8CO
20X150	1/2		150 100 275	CM13G1/2CO
24X150	1/4		150 100 276	CM17G1/4CO
24X150	3/8		150 100 280	CM17G3/8CO
24X150	1/2		150 100 285	CM17G1/2CO
30X150	1/2		150 100 290	CM21G1/2CO
30X150	3/4		150 100 295	CM21G3/4CO
36X150	3/4		150 100 300	CM27G3/4CO
36X150	1		150 100 305	CM27G1CO
45X150	1		150 100 310	CM33G1CO
45X150	1 1/4		150 100 311	CM33G1 1/4CO
52X150	1 1/4		150 100 312	CM42G1 1/4CO

## COUDE EGAL MALE SERIE GAZ

Equal elbow male 24° gas



A	Filetage		Code origine	Référence origine
	B	C		
20X150	20X150		150 100 240	CE13G
24X150	24X150		150 100 245	CE17G
30X150	30X150		150 100 250	CE21G
36X150	36X150		150 100 255	CE27G
45X150	45X150		150 100 260	CE33G

## COUDE MALE-FEMELLE SERIE GAZ

Angular rotary fitting male-female 24° gas serie



A	Filetage		Code origine	Référence origine
	B	C		
20X150	20X150		150 100 315	CF13G
24X150	24X150		150 100 320	CF17G
30X150	30X150		150 100 325	CF21G
36X150	36X150		150 100 330	CF27G
45X150	45X150		150 100 331	CF33G



# TE / SÉRIE DIN L ET S



## TE EGAL MALE DIN 24° SERIE L/S

Equal tee male din 24° L/S serie



A	Filetage			Code origine	Référence origine
	B	C			
12X150	12X150	12X150		090 345 110	TE06L
14X150	14X150	14X150		090 345 130	TE08L
16X150	16X150	16X150		090 345 150	TE10L
18X150	18X150	18X150		090 345 160	TE12L
22X150	22X150	22X150		090 345 170	TE15L
26X150	26X150	26X150		090 345 180	TE18L
30X200	30X200	30X200		090 345 190	TE22L
36X200	36X200	36X200		090 345 200	TE28L
45X200	45X200	45X200		090 345 210	TE35L
52X200	52X200	52X200		090 345 220	TE42L
14X150	14X150	14X150		090 345 230	TE06S
16X150	16X150	16X150		090 345 240	TE08S
18X150	18X150	18X150		090 345 250	TE10S
20X150	20X150	20X150		090 345 260	TE12S
22X150	22X150	22X150		090 345 270	TE14S
24X150	24X150	24X150		090 345 280	TE16S
30X200	30X200	30X200		090 345 290	TE20S
36X200	36X200	36X200		090 345 300	TE25S
42X200	42X200	42X200		090 345 310	TE30S
52X200	52X200	52X200		090 345 320	TE38S

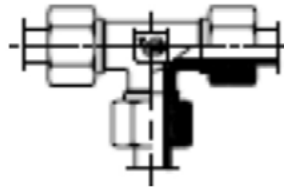

# TE SÉRIE GAZ FRANÇAIS



## TE EGAL MALE SERIE GAZ

Equal tee male 24° gas serie



A	Filetage			Code origine	Référence origine
	B	C			
20X150	20X150	20X150		150 100 335	TE13G
24X150	24X150	24X150		150 100 340	TE17G
30X150	30X150	30X150		150 100 345	TE21G
36X150	36X150	36X150		150 100 350	TE27G
45X150	45X150	45X150		150 100 355	TE33G

# COUPLEURS



## COUPLEUR A CLAPET NV SERIE DIN MALE

Equal tee male 24° gas serie



Diam. Accouplement	Filetage	P. Serv (bars)	Débit L/min.	Code origine	Référence origine
14,10	1/4 BSPP	350	15	100 120 100	CM1/4NV
18,91	3/8 BSPP	300	50	100 120 110	CM3/8NV
20,50	1/2 BSPP	300	75	100 120 120	CM1/2NV
20,50	1/2 BSPP	300	75	100 120 130	CM1/2NV-22
27,92	3/4 BSPP	300	150	100 120 140	CM3/4NV
31,30	1 BSPP	250	230	100 120 150	CM1NV
43,96	1 1/4 BSPP	220	340	100 120 160	CM1 1/4NV
53,40	1 1/2 BSPP	200	450	100 120 170	CM1 1/2NV
81,90	2 BSPP	150	1000	100 120 180	CM2NV

## COUPLEUR A CLAPET NV SERIE DIN FEMELLE



Diam. Accouplement	Filetage	P. Serv (bars)	Débit L/min.	Code origine	Référence origine
	1/4 BSPP	350	15	100 140 100	CF1/4NV
	3/8 BSPP	300	50	100 140 110	CF3/8NV
	1/2 BSPP	300	75	100 140 120	CF1/2NV
	1/2 BSPP	300	75	100 140 130	CF1/2PV
	1/2 BSPP	300	75	100 140 140	CF1/2NV-22
	3/4 BSPP	300	150	100 140 150	CF3/4NV
	1 BSPP	250	230	100 140 160	CF1NV
	1 1/4 BSPP	220	340	100 140 170	CF1 1/4NV
	1 1/2 BSPP	200	450	100 140 180	CF1 1/2NV
	2 BSPP	150	1000	100 140 190	CF2NV



### COUPLEUR FACE PLANE SERIE FFH MALE



Diam. Accouplement	Filetage	P. Serv (bars)	Débit L/min.	Code origine	Référence origine
16,10	1/4 BSPP	350	25	100 180 100	CMFP1/4FFH
19,72	3/8 BSPP	350	50	100 180 110	CMFP3/8FFH
19,72	1/2 BSPP	350	50	100 180 120	CMFP3/8FFH1/2
19,72	3/4UNF	350	50	100 180 130	CMFP3/8FFH3/4U
24,50	1/2 BSPP	350	110	100 180 140	CMFP1/2FFH
24,50	3/4 BSPP	350	110	100 180 150	CMFP1/2FFH3/4
29,90	3/4 BSPP	350	160	100 180 160	CMFP3/4FFH
29,90	1 BSPP	350	160	100 180 170	CMFP3/4FFH1
36,00	1 1/4 BSPP			100 180 180	CMFP1FFH1 1/4
36,00	1 1/2 BSPP			100 180 190	CMFP1FFH1 1/2

### COUPLEUR FACE PLANE SERIE FFH FEMELLE



Diam. Accouplement	Filetage	P. Serv (bars)	Débit L/min.	Code origine	Référence origine
	1/4 BSPP	350	25	100 200 100	CFFP1/4FFH
	3/8 BSPP	350	50	100 200 110	CFFP3/8FFH
	3/4UNF	350	50	100 200 120	CFFP3/8FFH3/4U
	1/2 BSPP	350	50	100 200 130	CFFP3/8FFH1/2
	1/2 BSPP	350	110	100 200 140	CFFP1/2FFH
	3/4 BSPP	350	110	100 200 150	CFFP1/2FFH3/4
	3/4 BSPP	350	160	100 200 160	CFFP3/4FFH
	1 BSPP	350	160	100 200 170	CFFP3/4FFH1
	1 1/4 BSPP			100 200 180	CFFP1FFH1 1/4
	1 1/2 BSPP			100 200 190	CFFP1FFH1 1/2



## VALVES



### VALVES AGRICOLE



Diam. Accouplement	Filetage	P. Serv (bars)	Débit L/min.	Code origine	Référence origine
	1/2BSP			100 300 100	VAFR
	male 20X150			100 300 105	VAFT
	18X150			100 300 110	VAR08
	male 20X150			100 300 115	VAT08
	male 1/2CYL			100 300 120	VAT08MICYL1/2
				100 300 125	VAT08CM1/2NV
	24X150			100 301 100	V12R
	24X150			100 301 110	V12T



## VANNES



### ROBINET A BOISSEAU 2 VOIES



DN	P. Ser. (bars)	Code origine	Référence origine
6	500	110 041 010	RBS2V1/4-SCH
10	500	110 041 020	RBS2V3/8-SCH
12	500	110 041 030	RBS2V1/2-SCH
20	400	110 041 040	RBS2V3/4-SCH
25	350	110 041 050	RBS2V1-SCH







ZI, ROUTE D'EVRECY | 14310 VILLERS BOCAGE  
02 31 25 40 07 | contact@pm-didot.fr



**Chantal**  
Comptabilité



**Sylvain**  
Atelier



**Pierre**  
Commercial



**Corinne**  
Commandes  
& SAV



**Arnaud**  
Commercial

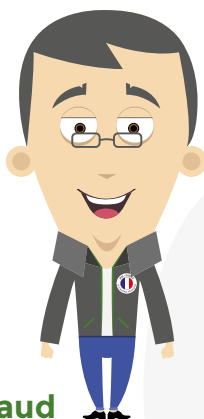

**Delphine**  
Site internet  
& Transport

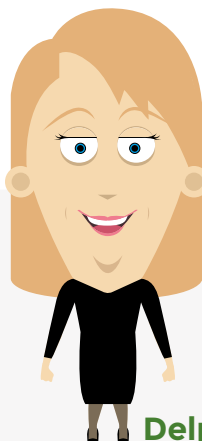

**Thibault**  
Commandes  
& SAV



**Frédéric**  
Direction

